

# Profile milling

Inserts

Face milling cutters

Square shoulder cutters

Slot cutters

Porcupine cutters

Specific applications and Sets

Profile milling



# Profile milling

Technical information	G.02
Applications	G.03
Roughing ball nose	G.04
Finishing ball nose	G.08
Toroidal cutters	G.14
High feed	G.18
Round inserts	G.24
Aluminium die cutting	G.30

Profile milling

Solid carbide

Drills

Boring heads

Arbors and adaptors

- Inserts
- Face milling cutters
- Square shoulder cutters
- Slot cutters
- Porcupine cutters
- Specific applications and Sets
- Profile milling**

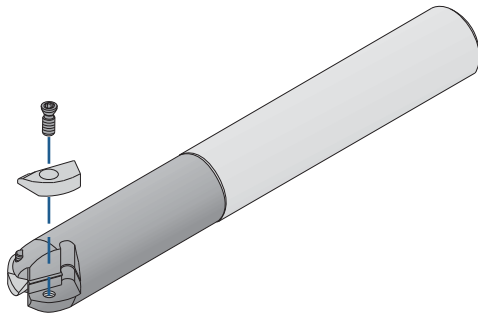

### Screw clamping

Since the advent of the Torx screw it has been possible to hold with complete safety positive inserts with center hole. Our range covers all the screw clamping permutations.

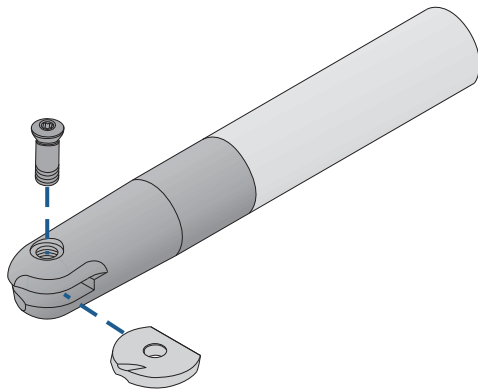

### Center screw clamping

Grinded high accuracy center screws ensures that the insert is firmly fixed. This clamping system is only used for finishing applications.

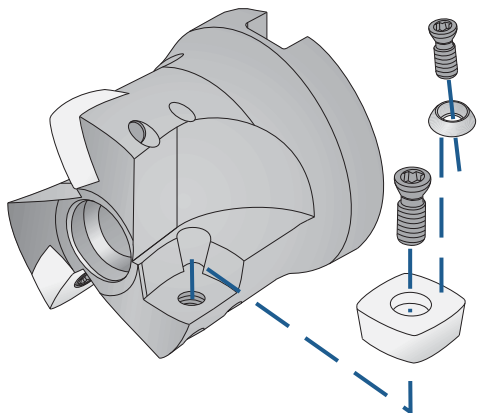

### Double clamping

Heavy duty work require good fixation, for this purpose we have as designed our double clamping system, one of the safest available.

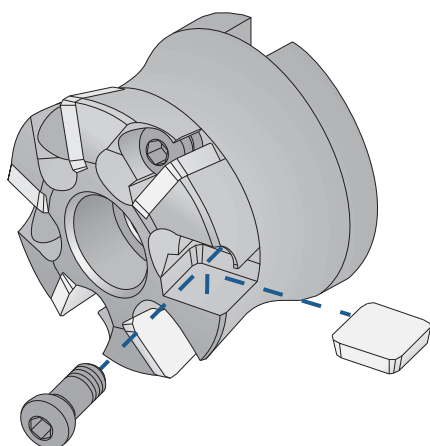



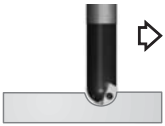
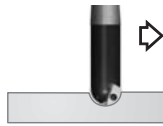

### Wedge screw

This easy and clean clamping system has been designed for the high feed cutters with flat inserts. The wedge screw clamping system offers good chip evacuation and easy use.

**Roughing ball nose**

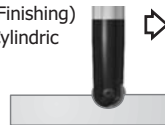
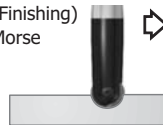
<p><b>3540.0<sub>1</sub></b> Roughing (Cylindric)</p>  <p>Page G.04 IN.. 25 IN.. 32</p>	<p><b>3540.3<sub>4</sub></b> Roughing (Morse)</p>  <p>IN.. 32 ... IN.. 50</p> <p>Page G.05</p>				
----------------------------------------------------------------------------------------------------------------------------------------------------------------------------------	---------------------------------------------------------------------------------------------------------------------------------------------------------------------------------------------	--	--	--	--



**Finishing ball nose**

<p><b>85_0</b> Copy applications (Finishing) Cylindric</p>  <p>WPR 10 ... WPR 32</p> <p>Page G.08</p>	<p><b>85_3</b> Copy applications (Finishing) Morse</p>  <p>WPR 20 ... WPR 32</p> <p>Page G.09</p>	<p><b>85_06</b> Copy applications (Finishing) Modular</p>  <p>WPR 10 ... WPR 25</p> <p>Page G.10</p>	<p><b>88_0</b> Copy applications (Finishing) Cylindric</p>  <p>RPR 10 ... RPR 32</p> <p>Page G.11</p>	<p><b>88_3</b> Copy applications (Finishing) Morse</p>  <p>RPR 20 ... RPR 32</p> <p>Page G.12</p>	<p><b>88_06</b> Copy applications (Finishing) Modular</p>  <p>RPR 10 ... RPR 25</p> <p>Page G.13</p>
------------------------------------------------------------------------------------------------------------------------------------------------------------------------------------------------------------	--------------------------------------------------------------------------------------------------------------------------------------------------------------------------------------------------------	-----------------------------------------------------------------------------------------------------------------------------------------------------------------------------------------------------------	------------------------------------------------------------------------------------------------------------------------------------------------------------------------------------------------------------	----------------------------------------------------------------------------------------------------------------------------------------------------------------------------------------------------------	-------------------------------------------------------------------------------------------------------------------------------------------------------------------------------------------------------------

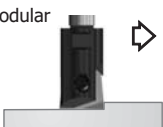



**Toroidal cutters**

<p><b>89_01</b> Back draft cutter Cylindric</p>  <p>MTK 12 MTK ... MTK 25</p> <p>Page G.14</p>	<p><b>89_06</b> Back draft cutter Modular</p>  <p>MTK 10 MTK ... MTK 25</p> <p>Page G.15</p>				
--------------------------------------------------------------------------------------------------------------------------------------------------------------------------------------------------	------------------------------------------------------------------------------------------------------------------------------------------------------------------------------------------------	--	--	--	--



**High feed**

<p><b>1635.00</b> High feed</p>  <p>Page G.18 XDKW 0904..</p>	<p><b>1645.90</b> High feed</p>  <p>Page G.19 XDKW 1204..</p>	<p><b>1440.90</b> High feed</p>  <p>Page G.20 SP.. 1203..</p>			
--------------------------------------------------------------------------------------------------------------------------------------------------	--------------------------------------------------------------------------------------------------------------------------------------------------	--------------------------------------------------------------------------------------------------------------------------------------------------	--	--	--

**Round Inserts**

<p><b>55_5</b> Round milling</p>  <p>RDHW 0702.. RDHW 1604..</p> <p>Page G.24</p>	<p><b>55_5.06</b> Round milling</p>  <p>RDHW 0702.. RDHW 1604..</p> <p>Page G.25</p>	<p><b>55<sub>4</sub>5.90</b> Round milling</p>  <p>RD.. 12T3M0 RD.. 1604M0</p> <p>Page G.26</p>	<p><b>5549.90</b> Round milling</p>  <p>RPM.. 1204..</p> <p>Page G.27</p>		
--------------------------------------------------------------------------------------------------------------------------------------------------------------------------	-----------------------------------------------------------------------------------------------------------------------------------------------------------------------------	--------------------------------------------------------------------------------------------------------------------------------------------------------------------------------------------	------------------------------------------------------------------------------------------------------------------------------------------------------------------	--	--

**Aluminium die cutting**

<p><b>0344.06</b> General application</p>  <p>VC.. 1103.. VC.. 2205..</p> <p>Page G.30</p>	<p><b>0344.90</b> General application</p>  <p>VC.. 2205..</p> <p>Page G.31</p>				
---------------------------------------------------------------------------------------------------------------------------------------------------------------------------------------	-----------------------------------------------------------------------------------------------------------------------------------------------------------------------	--	--	--	--

Profile milling  
Solid carbide  
Drills  
Boring heads  
Arbors and adaptors

Inserts

Face milling cutters

Square shoulder cutters

Slot cutters

Porcupine cutters

Specific applications and Sets

Profile milling



**Characteristics:**

Indexable ball nose roughing cutter equipped with positive insert that provides low cutting forces and reduced vibration. Its accurate pocket ensures that the insert is firmly fixed. The insert is fixed by Torx screw that allow a good chip evacuation and easy use. Milling cutter equipped with cylindrical shank.

**Applications:**

Ball end mill roughing applications for tool and die. This indexable ball nose cutter works well on steels, hardened steels, stainless steels and casts.

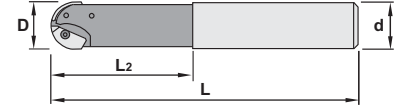
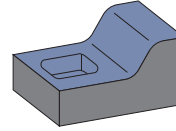
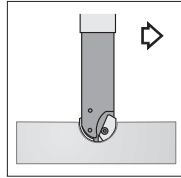

## 3540.0<sub>1</sub><sup>0</sup>

Ref.			D	L	L2	d	Insert size	
3540.00.025	2		25	115	57	25	IN.. 25	0,400
3540.00.032	2		32	115	57	32	IN.. 32	0,500
3540.01.025	2		25	150	76	25	IN.. 25	0,650
3540.01.032	2		32	150	76	32	IN.. 32	0,850



Ref.	3540.00.025	1235	5615
	3540.00.032	1550	5620
	3540.01.025	1235	5615
	3540.01.032	1550	5620

Ref.	IN..			Positive ball nose insert.
	l	s	d	
IN.. 25	-	4,5	12,5	For more information see page: A.13
IN.. 32	-	5,6	16,0	
	INT	INW		



**Characteristics:**

Indexable ball nose roughing cutter equipped with positive insert that provides low cutting forces and reduced vibration. Its accurate pocket ensures that the insert is firmly fixed.

The insert is fixed by Torx screw that allow a good chip evacuation and easy use.

Milling cutter equipped with Morse shank.

**Applications:**

Ball end mill roughing applications for tool and die. This indexable ball nose cutter works well on steels, hardened steels, stainless steels and casts.

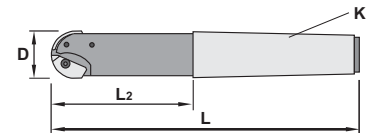
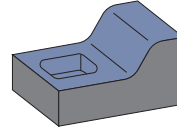
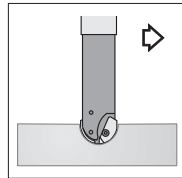

3540.3 <sup>4</sup> <sub>5</sub>			D	L	L2	K	Insert size	
Ref.	3540.34.032	2	32	228	119	4	IN.. 32	1,150
	3540.35.040	2	40	231	95	5	IN.. 40	2,120
	3540.35.050	2	50	231	95	5	IN.. 50	2,850

Ref.		
3540.34.032	1550	5620
3540.35.040	1250	5620
3540.35.050	1890	5625

Ref.	IN..	l	s	d	Positive ball nose insert.
	IN.. 32	-	5,6	16,0	
IN.. 40	-	5,6	20,0		
IN.. 50	-	7,9	25,0		

  

INT	INW				

For more information see page: A.13

Profile milling  
Solid carbide  
Drills  
Boring heads  
Arbors and adaptors

## Recommended cutting conditions

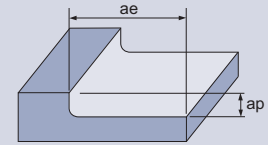

### Side Milling

Material	m/min Actual Maximum Cutting Speed	mm/tooth Feed rate	Ø20		Ø25		Ø32		Ø40	
			min <sup>-1</sup>	mm/min	min <sup>-1</sup>	mm/min	min <sup>-1</sup>	mm/min	min <sup>-1</sup>	mm/min
Carbon Steels (200 HB)	150-250	0,15-0,6	3500	4200	2800	3360	2330	2800	1430	1720
		Vc=220m/min ap<=1,0mm ae=0,3D								1430
Alloy Steels (200-250 HB)	120-200	0,1-0,3	3500	650	2800	880	2330	720	1430	540
		Vc=220m/min ap=0,5mm ae=0,3D								1430
Alloy Steels (25-35 HRC)	60-120	0,15-0,6	3180	3820	2550	3060	2120	2550	1270	1530
		Vc=200m/min ap<=1,0mm ae=0,3D								1270
Alloy Steels (25-35 HRC)	60-120	0,08-0,3	3180	540	2550	660	2120	530	1270	410
		Vc=200m/min ap=0,5mm ae=0,3D								1270
Alloy Steels Pre-Harden Steels (40-45 HRC)	50-100	0,08-0,6	2070	2500	1660	2000	1380	1650	870	1050
		Vc=130m/min ap<=1,0mm ae=0,3D								870
Alloy Steels Pre-Harden Steels (40-45 HRC)	50-100	0,05-0,3	2070	440	1660	540	1380	460	870	330
		Vc=130m/min ap=0,5mm ae=0,3D								870
Cast Iron (150HB)	120-240	0,07-0,6	1110	1330	890	1070	740	900	560	670
		Vc=70m/min ap<=1,0mm ae=0,3D								560
Cast Iron (150HB)	120-240	0,05-0,3	1110	150	890	200	740	200	560	100
		Vc=70m/min ap=0,5mm ae=0,3D								560
Cast Iron (150HB)	120-240	0,15-1,2	3500	4200	2800	3360	2230	2800	1430	1720
		Vc=220m/min ap<=1,0mm ae=0,3D								1430
Cast Iron (150HB)	120-240	0,1-0,3	3500	650	2800	900	2230	900	1430	540
		Vc=220m/min ap=0,5mm ae=0,3D								1430

Note

- The cutting data in the table show conditions for VB30=0,3mm (flank wear 30min tool-life).  
Overhang is the length below the chuck (l b)

- RPM for high-speed machines is calculated using the following formula:  $Revolution\ Speed = \frac{500 \times Actual\ Maximum\ Cutting\ Speed}{\pi \times \sqrt{2} \times R \times ap-ap^2}$

- Actual Maximum Cutting Speed:  
ap=0,5mm and 1mm  
Maximum Cutting Speed at boundary of contact part with work material under the above recommended cutting condition

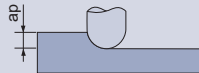

- Cutting conditions on high-speed machine tools are recommended for contouring path milling.

- 3-5° slant milling is recommended for pocketing using a 70% feed rate, please reduce slant angle below 3° for harder materials. Please use machine guards when cutting steel due to flying chips.

### Deep Side Milling

Material	m/min Cutting Speed	mm/tooth Feed rate	Ø20		Ø25		Ø30		Ø40	
			min <sup>-1</sup>	mm/min	min <sup>-1</sup>	mm/min	min <sup>-1</sup>	mm/min	min <sup>-1</sup>	mm/min
Carbon Steels (200 HB)	120-200	0,08-0,2	2700	420	2160	530	1800	440	1110	420
			Vc=170m/min ap=1,2D ae=0,1D							
Alloy Steels (200-250 HB)	120-200	0,06-0,2	2550	320	2040	430	1700	350	1270	410
			Vc=160m/min ap=1,2D ae=0,1D							
Alloy Steels (25-35 HRC)	100-160	0,05-0,15	1750	220	1400	330	1170	270	790	300
			Vc=110m/min ap=1,2D ae=0,1D							
Hardened Steels Pre-Harden Steels (40-45 HRC)	60-120	0,04-0,13	960	70	760	100	640	100	480	90
			Vc=60m/min ap=1,2D ae=0,1D							
Cast Iron (150HB)	140-220	0,08-0,2	2700	420	2160	530	1800	440	1110	420
			Vc=170m/min ap=1,2D ae=0,1D							

## Recommended cutting conditions

### Slotting

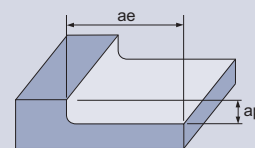

Material	m/min Cutting Speed	mm/tooth Feed rate	Ø20		Ø25		Ø30		Ø40			
			min <sup>-1</sup>	mm/min	min <sup>-1</sup>	mm/min	min <sup>-1</sup>	mm/min	min <sup>-1</sup>	mm/min		
Carbon Steels (200 HB)	150-250	0,06-0,2	3500	440	2800	550	2330	720	1430	440		
			Vc=220m/min						Vc=180m/min			
			ap=0,3D									
Alloy Steels (200-250 HB)	150-230	0,05-0,2	3180	330	2550	450	2120	420	1270	340		
			Vc=200m/min						Vc=160m/min			
			ap=0,3D									
Alloy Steels (25-35 HRC)	100-160	0,03-0,15	2070	110	1660	210	1380	180	870	170		
			Vc=130m/min						Vc=110m/min			
			ap=0,3D									
Hardened Steels Pre-Harden Steels (40-45 HRC)	60-120	0,02-0,13	1100	50	890	80	740	80	560	100		
			Vc=70m/min									
			ap=0,3D									
Cast Iron (150HB)	140-240	0,06-0,2	3500	440	2800	660	2330	540	1430	540		
			Vc=220m/min						Vc=180m/min			
			ap=0,3D									

Note

- These conditions are for general guidance; in actual machining conditions adjust the parameters according to your actual machine and work-piece conditions.
- For long type please reduce speed and feed by 70%.
- In case of using Long Shank Type, no relation to diameters, basic conditions are:  
 n=700min<sup>-1</sup>  
 Vf=210m/min  
 ap=0,1D  
 ae=0,3D

- Profile milling
- Solid carbide
- Drills
- Boring heads
- Arbors and adaptors

Inserts

Face milling cutters

Square shoulder cutters

Slot cutters

Porcupine cutters

Specific applications and Sets

Profile milling



**Characteristics:**

Indexable ball nose semi-finishing and finishing cutter equipped with positive insert that provides low cutting forces and reduced vibration. Its accurate pocket ensures that the insert is firmly fixed.

Milling cutter equipped with cylindrical shank.

**Applications:**

Ball end mill for tool and die applications. This indexable ball nose cutter works well on steels, hardened steels, stainless steels and casts.

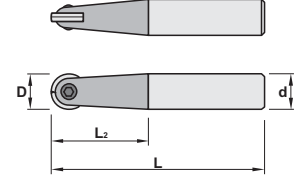
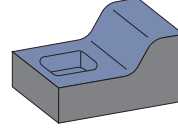
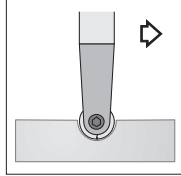

85_0			D	L	L2	d	Insert size	
Ref.	8530.00.010	2	10	105	50	12	WPR 10	0,100
	8540.00.012	2	12	105	50	16	WPR 12	0,240
	8550.00.016	2	16	105	50	20	WPR 16	0,260
	8560.00.020	2	20	125	70	25	WPR 20	0,500
	8580.00.025	2	25	125	70	32	WPR 25	0,750
	8590.00.032	2	32	125	70	32	WPR 32	0,800
	8530.01.010	2	10	150	80	12	WPR 10	0,200
	8540.01.012	2	12	160	90	16	WPR 12	0,300
	8550.01.016	2	16	180	100	20	WPR 16	0,400
	8560.01.020	2	20	200	120	25	WPR 20	0,700
	8580.01.025	2	25	220	140	32	WPR 25	1,250
	8590.01.032	2	32	250	160	32	WPR 32	1,550

Ref.		
8530.00.010	1359	5615
8540.00.012	1509	5620
8550.00.016	1519	5620
8560.00.020	1529	5620
8580.00.025	1609	5530
8590.00.032	1809	5530
8530.01.010	1359	5615
8540.01.012	1509	5620
8550.01.016	1519	5620
8560.01.020	1529	5620
8580.01.025	1609	5530
8590.01.032	1809	5530

WPR		l	s	d	Positive 11° clearance - Round insert.
Ref.	WPR 10	-	2,40	10,00	
	WPR 12	-	2,50	12,00	
	WPR 16	-	3,00	16,00	
	WPR 20	-	3,00	20,00	
	WPR 25	-	4,00	25,00	
	WPR 32	-	5,00	32,00	

For more information see page: A.22

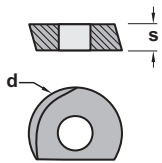



**Characteristics:**



Indexable ball nose semi-finishing and finishing cutter equipped with positive insert that provides low cutting forces and reduced vibration. Its accurate pocket ensures that the insert is firmly fixed. Milling cutter equipped with Morse shank.

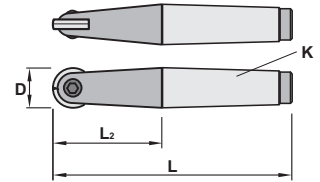
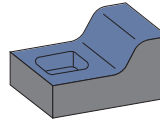
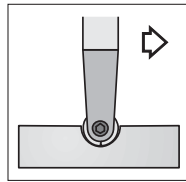

**Applications:**



Ball end mill for tool and die applications. This indexable ball nose cutter works well on steels, hardened steels, stainless steels and casts.



**85\_3**

Ref.		D	L	K	L2	Insert size	
8560.30.020	2	20	190	3	115	WPR 20	0,670
8580.34.025	2	25	215	4	135	WPR 25	1,150
8590.34.032	2	32	268	4	160	WPR 32	1,550

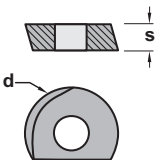
Ref.		
8560.30.020	1529	5620
8580.34.025	1609	5530
8590.34.032	1809	5530

<b>WPR</b>		l	s	d	Positive 11° clearance - Round insert.
Ref.	WPR 20	-	3,00	20,00	
	WPR 25	-	4,00	25,00	
	WPR 32	-	5,00	32,00	
For more information see page: A.22					
	<b>WPR</b>				
					

Profile milling  
Solid carbide  
Drills  
Boring heads  
Arbors and adaptors

Inserts

Face milling cutters

Square shoulder cutters

Slot cutters

Porcupine cutters

Specific applications and Sets

Profile milling



Shanks page: K.45 - K.48

**Characteristics:**

Indexable ball nose semi-finishing and finishing cutter equipped with positive insert that provides low cutting forces and reduced vibration. Its accurate pocket ensures that the insert is firmly fixed.

Milling cutter equipped with modular shank.

**Applications:**

Ball end mill for tool and die applications. This indexable ball nose cutter works well on steels, hardened steels, stainless steels and casts.

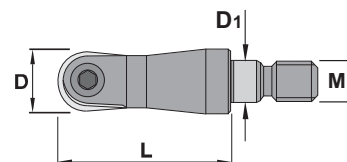
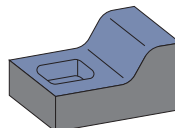
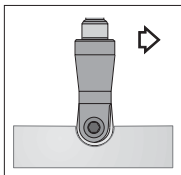

85_06			D	L	M	D1	Insert size	
Ref.	8530.06.010	2	10	23	M6	6,5	WPR 10	0,016
	8540.06.012	2	12	23	M6	6,5	WPR 12	0,030
	8550.06.016	2	16	30	M8	8,5	WPR 16	0,050
	8560.06.020	2	20	35	M10	10,5	WPR 20	0,095
	8580.06.025	2	25	40	M12	12,5	WPR 25	0,160

Ref.		
8530.06.010	1359	5515
8540.06.012	1509	5520
8550.06.016	1519	5520
8560.06.020	1529	5520
8580.06.025	1609	5530

Ref.	WPR			Positive 11° clearance - Round insert.
	l	s	d	
WPR 10	-	2,40	10,00	For more information see page: A.22
WPR 12	-	2,50	12,00	
WPR 16	-	3,00	16,00	
WPR 20	-	3,00	20,00	
WPR 25	-	4,00	25,00	



**Characteristics:**

Indexable ball nose mirror finishing cutter equipped with positive insert that provides low cutting forces and reduced vibration. Its accurate pocket ensures that the insert is firmly fixed. Milling cutter equipped with cylindrical shank.

**Applications:**

Ball end mill for tool and die applications. This indexable ball nose cutter works well on steels, hardened steels, stainless steels and casts.

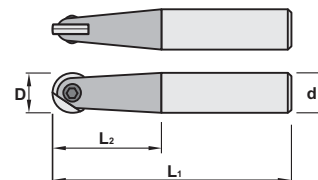
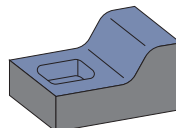
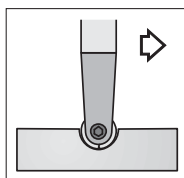



**88\_0**

Ref.			D	L1	d	L2	Insert size	
8830.00.010	2		10	105	10	50	RPR 10	0,100
8840.00.012	2		12	105	12	50	RPR 12	0,240
8850.00.016	2		16	105	16	50	RPR 16	0,260
8860.00.020	2		20	125	20	70	RPR 20	0,500
8880.00.025	2		25	125	25	70	RPR 25	0,750
8890.00.032	2		32	125	32	70	RPR 32	0,800
8830.01.010	2		10	150	10	80	RPR 10	0,200
8840.01.012	2		12	160	12	90	RPR 12	0,300
8850.01.016	2		16	180	16	100	RPR 16	0,400
8860.01.020	2		20	200	20	120	RPR 20	0,700
8880.01.025	2		25	220	25	140	RPR 25	1,250
8890.01.032	2		32	250	32	160	RPR 32	1,550

Ref.		
8830.00.010	1353	5608
8840.00.012	1354	5610
8850.00.016	1619	5615
8860.00.020	1529	5620
8880.00.025	1609	5530
8890.00.032	1809	5530
8830.01.010	1353	5608
8840.01.012	1354	5610
8850.01.016	1619	5615
8860.01.020	1529	5620
8880.01.025	1609	5530
8890.01.032	1809	5530

<b>RPR</b>		<b>l</b>	<b>s</b>	<b>d</b>	Positive 11° clearance - Round insert.
Ref.	RPR 10	-	2,60	10,00	
	RPR 12	-	3,00	12,00	
	RPR 16	-	4,00	16,00	
	RPR 20	-	5,00	20,00	
	RPR 25	-	6,00	25,00	
	RPR 32	-	7,00	32,00	

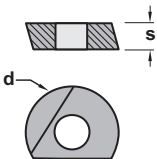
For more information see page: A.16

Profile milling  
Solid carbide  
Drills  
Boring heads  
Arbors and adaptors

Inserts

Face milling cutters

Square shoulder cutters

Slot cutters

Porcupine cutters

Specific applications and Sets

Profile milling



### Characteristics:

Indexable ball nose mirror finishing cutter equipped with positive insert that provides low cutting forces and reduced vibration. Its accurate pocket ensures that the insert is firmly fixed.

Milling cutter equipped with Morse shank.

### Applications:

Ball end mill for tool and die applications. This indexable ball nose cutter works well on steels, hardened steels, stainless steels and casts.

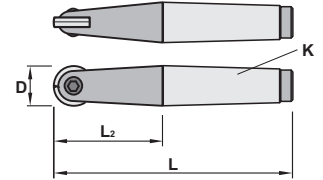
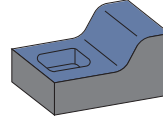
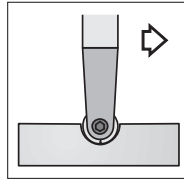

88_3			D	L	K	L2	Insert size	
Ref.	8860.30.020	2	20	190	3	115	RPR 20	0,670
	8880.34.025	2	25	215	4	135	RPR 25	1,200
	8890.34.032	2	32	268	4	160	RPR 32	1,650

Ref.	8860.30.020		1529		5620
	8880.34.025		1609		5530
	8890.34.032		1809		5530

Ref.	RPR			Positive 11° clearance - Round insert.
	l	s	d	
RPR 20	-	5,00	20,00	For more information see page: A.19
RPR 25	-	6,00	25,00	
RPR 32	-	7,00	32,00	
RPR				



Shanks page: K.45 - K.48

**Characteristics:**

Indexable ball nose mirror finishing cutter equipped with positive insert that provides low cutting forces and reduced vibration. Its accurate pocket ensures that the insert is firmly fixed.

Milling cutter equipped with modular shank.

**Applications:**

Ball end mill for tool and die applications. This indexable ball nose cutter works well on steels, hardened steels, stainless steels and casts.

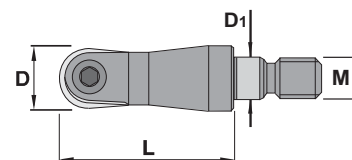
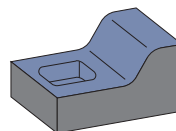
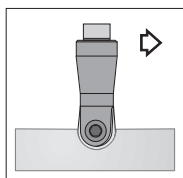

# 88\_06

Ref.		D	L	M	D1	Insert size	
8830.06.010	2	10	23	M6	6,5	RPR 10	0,016
8840.06.012	2	12	23	M6	6,5	RPR 12	0,030
8850.06.016	2	16	30	M8	8,5	RPR 16	0,050
8860.06.020	2	20	30	M10	10,5	RPR 20	0,095
8880.06.025	2	25	35	M12	12,5	RPR 25	0,160

Ref.		
8830.06.010	1353	5508
8840.06.012	1354	5510
8850.06.016	1619	5515
8860.06.020	1529	5520
8880.06.025	1609	5530

RPR		l	s	d	Positive 11° clearance - Round insert.
Ref.	RPR 10	-	2,60	10,00	
	RPR 12	-	3,00	12,00	
	RPR 16	-	4,00	16,00	
	RPR 20	-	5,00	20,00	
	RPR 25	-	6,00	25,00	

For more information see page: A.19

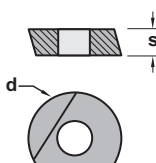

Profile milling  
Solid carbide  
Drills  
Boring heads  
Arbors and adaptors

Inserts

Face milling cutters

Square shoulder cutters

Slot cutters

Porcupine cutters

Specific applications and Sets

Profile milling



### Characteristics:

Indexable back draft cutter equipped with positive insert that provides low cutting forces and reduced vibration. Its accurate pocket ensures that the insert is firmly fixed.

Milling cutter equipped with cylindrical shank.

### Applications:

Back draft cutter for tool and die applications. This indexable back draft cutter works well on steels, hardened steels, stainless steels and casts.

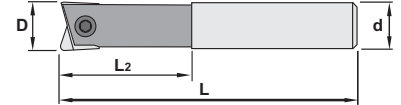
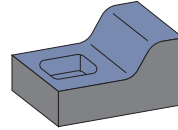
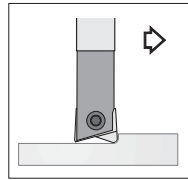

89_01			D	L	d	L2	Insert size	
Ref.	8940.01.012	2	12	110	12	53	MTK 12	0,090
	8950.01.016	2	16	125	16	63	MTK 16	0,180
	8960.01.020	2	20	140	20	75	MTK 20	0,290
	8980.01.025	2	25	180	25	90	MTK 25	0,600

Ref.		
8940.01.012	1354	5608
8950.01.016	1619	5610
8960.01.020	1629	5615
8980.01.025	1609	5530

 MTK FR  MTK FB	MTK			Toroidal insert.
	Ref.	l	r	
	MTK 12	12,00	1,00	For more information see page: A.14
	MTK 16	16,00	1,30	
	MTK 20	20,00	1,60	
	MTK 25	25,00	2,00	
	MTK			



Shanks page: K.45 - K.48

**Characteristics:**

Indexable back draft cutter equipped with positive insert that provides low cutting forces and reduced vibration. Its accurate pocket ensures that the insert is firmly fixed.

Milling cutter equipped with modular shank.

**Applications:**

Back draft cutter for tool and die applications. This indexable back draft cutter works well on steels, hardened steels, stainless steels and casts.

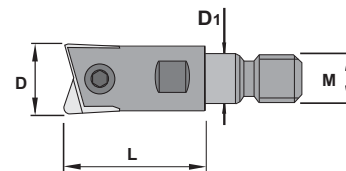
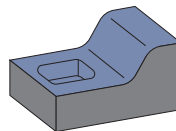
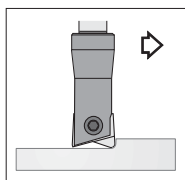

**89\_06**

Ref.		D	L	M	D1	Insert size	
8930.06.010	2	10	23	M6	6,5	MTK 10	0,016
8940.06.012	2	12	23	M6	6,5	MTK 12	0,030
8950.06.016	2	16	30	M8	8,5	MTK 16	0,050
8960.06.020	2	20	30	M10	10,5	MTK 20	0,095
8980.06.025	2	25	35	M12	12,5	MTK 25	0,160

Ref.		
8930.06.010	1353	5508
8940.06.012	1354	5510
8950.06.016	1619	5515
8960.06.020	1629	5520
8980.06.025	1609	5530

<b>MTK</b>		<b>l</b>	<b>r</b>	Toroidal insert.
Ref.	<b>MTK 10</b>	10,00	0,60	
	<b>MTK 12</b>	12,00	1,00	
	<b>MTK 16</b>	16,00	1,30	
	<b>MTK 20</b>	20,00	1,60	
	<b>MTK 25</b>	25,00	2,00	
For more information see page: A.14				
	<b>MTK</b>			

Profile milling

Solid carbide

Drills

Boring heads

Arbors and adaptors

Inserts

Face milling cutters

Square shoulder cutters

Slot cutters

Porcupine cutters

Specific applications and Sets

Profile milling

## Recommended cutting conditions

Material	m/min Cutting speed	mm/tooth Feed rate	Ø8		Ø10		Ø12			
			min <sup>-1</sup>	mm/min	min <sup>-1</sup>	mm/min	min <sup>-1</sup>	mm/min		
Carbon Steels Alloy Steels (30 HRC)	100-200	0,2-0,3	6370	2550	5090	2040	4240	1700		
			Vc=160m/min fz=0,2mm/tooth ap=0,025D ae=0,1D							
Carbon Steels Alloy Steels (30-40 HRC)	80-150	0,2-0,3	4770	1910	3820	1530	3180	1270		
			Vc=120m/min fz=0,2mm/tooth ap=0,025D ae=0,1D							
Die Tool Steels Pre-Harden Steels (30-40 HRC)	70-100	0,1-0,15	3180	640	2550	510	2120	420		
			Vc=80m/min fz=0,1mm/tooth ap=0,025D ae=0,1D							
Hardened Steels (55-65 HRC)	200-250	0,2-0,4	9150	3660	7320	2930	6100	2440		
			Vc=230m/min fz=0,2mm/tooth ap=0,01D ae=0,02D							
Cast Iron	100-200	0,3-0,4	6730	3820	5090	3050	4240	2550		
			Vc=160m/min fz=0,3mm/tooth ap=0,025D ae=0,1D							

Material	m/min Cutting speed	mm/tooth Feed rate	Ø16		Ø20		Ø25		Ø30(32)	
			min <sup>-1</sup>	mm/min	min <sup>-1</sup>	mm/min	min <sup>-1</sup>	mm/min	min <sup>-1</sup>	mm/min
Carbon Steels Alloy Steels (30 HRC)	100-200	0,2-0,3	2400	1600	2550	1300	2050	1030	1700	850
			Vc=160m/min fz=0,25mm/tooth ap=0,05D ae=0,1D							
Carbon Steels Alloy Steels (30-40 HRC)	80-150	0,2-0,3	1600	1200	1910	955	1530	765	1280	640
			Vc=120m/min fz=0,25mm/tooth ap=0,05D ae=0,1D							
Die Tool Steels Pre-Harden Steels (30-40 HRC)	70-100	0,1-0,15	3200	385	1280	310	1020	245	850	205
			Vc=80m/min fz=0,12mm/tooth ap=0,05D ae=0,1D							
Hardened Steels (55-65 HRC)	200-250	0,2-0,4	4575	2740	3660	2200	2930	1760	2440	1460
			Vc=230m/min fz=0,3mm/tooth ap=0,01D ae=0,02D							
Cast Iron	100-200	0,3-0,4	3200	2240	2550	1790	2050	1440	1700	1190
			Vc=160m/min fz=0,35mm/tooth ap=0,05D ae=0,1D							

**Note**

- According to the machining situation, refer to the table above to determine the cutting conditions.
- Be sure to practice safety instructions and precautions such as wearing glasses and safety shoes, and placing safety covers when you use this tool. Because this tool can be broken during machining so failure to follow these instructions may cause personal injury.
- Never attempt to modify the carbide shank holder. Use the value for the depth of cut (ap) when the carbide shank holder is used.  
 Mill diameters D=8~12mm:ap<=0,2mm.  
 Mill diameters D=16~32mm:ap<=0,3mm.

$$n = \frac{V_c \cdot 1000}{\pi \cdot \text{Def.}} \quad (\text{Rev./min.})$$

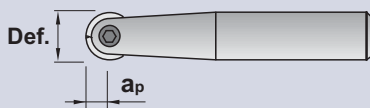

N = Spindle speed (Rev./min.)

Vc = Cutting speed

Def. = Effective cutting diameter

ap = Max. Depth of cut (mm)

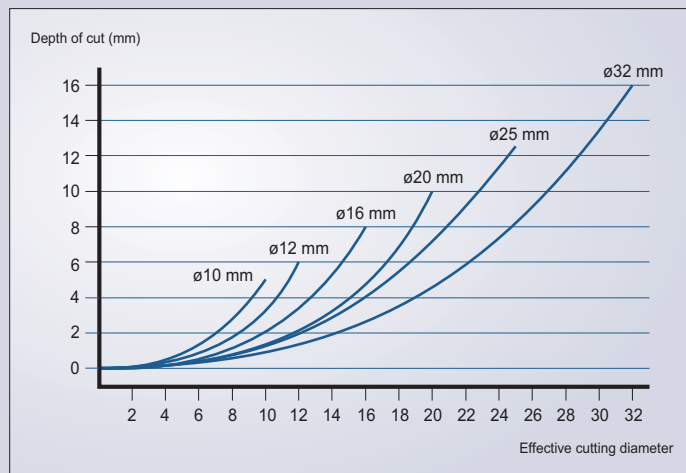

## Recommended cutting conditions

Material	m/min Cutting speed	mm/tooth Feed rate	Ø10		Ø12	
			min <sup>-1</sup>	mm/min	min <sup>-1</sup>	mm/min
Carbon Steels Alloy Steels (30 HRC)	100-200	0,1-0,2	5090	2040	4240	1700
			Vc=160m/min fz=0,2mm/tooth ap=0,025D ae=0,1D			
Carbon Steels Alloy Steels (30-40 HRC)	80-150	0,1-0,2	3820	1530	3180	1270
			Vc=120m/min fz=0,2mm/tooth ap=0,025D ae=0,1D			
Die Tool Steels Pre-Harden Steels (30-40 HRC)	70-100	0,05-0,1	2550	510	2120	420
			Vc=80m/min fz=0,1mm/tooth ap=0,025D ae=0,1D			
Hardened Steels (55-65 HRC)	130-180	0,05-0,1	5090	1020	4240	850
			Vc=160m/min fz=0,1mm/tooth ap=0,01D ae=0,02D			
Cast Iron	100-200	0,2-0,3	5090	3050	4240	2550
			Vc=160m/min fz=0,3mm/tooth ap=0,025D ae=0,1D			

Material	m/min Cutting speed	mm/tooth Feed rate	Ø16		Ø20		Ø25		Ø30(32)	
			min <sup>-1</sup>	mm/min	min <sup>-1</sup>	mm/min	min <sup>-1</sup>	mm/min	min <sup>-1</sup>	mm/min
Carbon Steels Alloy Steels (30 HRC)	100-200	0,1-0,2	3200	1600	2550	1300	2050	1030	1700	850
			Vc=160m/min fz=0,25mm/tooth ap=0,05D ae=0,1D							
Carbon Steels Alloy Steels (30-40 HRC)	80-150	0,1-0,2	2400	1200	1910	955	1530	765	1280	640
			Vc=120m/min fz=0,25mm/tooth ap=0,05D ae=0,1D							
Die Tool Steels Pre-Harden Steels (30-40 HRC)	70-100	0,05-0,1	1600	385	1280	310	1020	245	850	205
			Vc=80m/min fz=0,12mm/tooth ap=0,05D ae=0,1D							
Hardened Steels (55-65 HRC)	130-180	0,05-0,1	3180	950	2550	760	2040	610	1700	510
			Vc=160m/min fz=0,15mm/tooth ap=0,01D ae=0,02D							
Cast Iron	100-200	0,2-0,3	3200	2240	2550	1790	2050	1440	1700	1190
			Vc=160m/min fz=0,35mm/tooth ap=0,05D ae=0,1D							

Note

- According to the machining situation, refer to the table above to determine the cutting conditions.
- Be sure to practice safety instructions and precautions such as wearing glasses and safety shoes, and placing safety covers when you use this tool.
- Because this tool can be broken during machining so failure to follow these instructions may cause personal injury.
- Never attempt to modify the carbide shank holder. Use the value for the depth of cut (ap) when the carbide shank is used.  
Mill diameters D=8~12mm:ap<=0,05D.  
Mill diameters D=16~32mm:ap<=0,1D.
- PCA12M grade is suitable for not so high speed machining.

Inserts

Face milling cutters

Square shoulder cutters

Slot cutters

Porcupine cutters

Specific applications and Sets

Profile milling



**Characteristics:**

High feed square insert cutters for peripheral milling ramp milling and drilling, pocket milling and copy milling. Precision type inserts are available for efficient machining in most materials.

**Applications:**

This copying, milling cutter works well on hard steels, alloyed steels, stainless steels, refractory casts and aluminium alloys. A general milling cutter for diversified manufacture that allows using it in only one pass (roughing and finishing) and it is recommended for machining centers.

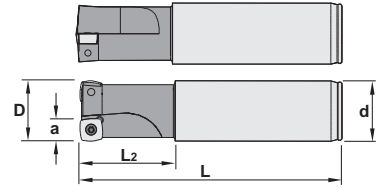
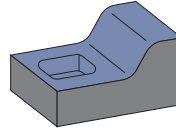
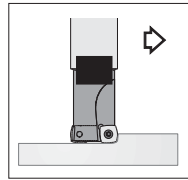

## 1635.00

Ref.		D	L	L2	d	a	Insert size	
1635.00.020	2	20	110	35	20	13	XDKW 090430	0,235
1635.00.025	2	25	110	35	25	13	XDKW 090430	0,350
1635.00.032	3	32	125	35	32	13	XDKW 090430	0,700

Ref.		
1635.00.020	1135	5510
1635.00.025	1135	5510
1635.00.032	1135	5510

XDKW				High feed.
Ref.	XDKW 090430	l	s	d
		9,00	4,76	9,00
For more information see page: A.23				
XDKW				

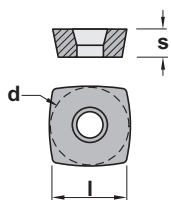



**Characteristics:**

High feed square insert cutters for peripheral milling ramp milling and drilling, pocket milling and copy milling. Precision type inserts are available for efficient machining in most materials.

**Applications:**

This copying, milling cutter works well on hard steels, alloyed steels, stainless steels, refractory casts and aluminium alloys. A general milling cutter for diversified manufacture that allows using it in only one pass (roughing and finishing) and it is recommended for machining centers.

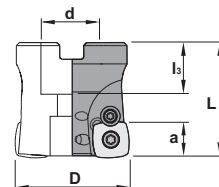
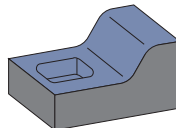
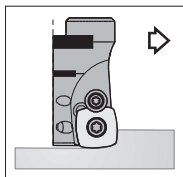

# 1645.90

Ref.		D	L	d	l3	a	Insert size	
1645.90.040	4	40	40	16	20	14	XDKW 120430	0,200
1645.90.050	5	50	50	22	22	14	XDKW 120430	0,300
1645.90.063	6	63	63	27	25	14	XDKW 120430	0,650
1645.90.080	5	80	80	27	25	14	XDKW 120430	1,150

Ref.			
1645.90.040	1240	5615	1058
1645.90.050	1240	5615	912,10
1645.90.063	1240	5615	912,12
1645.90.080	1240	5615	912,17

XDKW		l	s	d	High feed.
Ref.	XDKW 120430	12,50	4,76	12,50	
For more information see page: A.23					
XDKW					

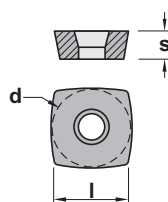

- Profile milling
- Solid carbide
- Drills
- Boring heads
- Arbors and adaptors

Inserts

Face milling cutters

Square shoulder cutters

Slot cutters

Porcupine cutters

Specific applications and Sets

Profile milling



**Characteristics:**

High feed positive milling cutter with 15° entering angle. Its strong inserts accept high feed per teeth. The original fixing system from Canela allows a quick insert assembly and dismantling.

**Applications:**

This face milling cutter works well on steels, stainless steel, alloyed steels, cast iron and aluminium alloys. This general purpose milling cutter is recommended for C.N.C. machines.

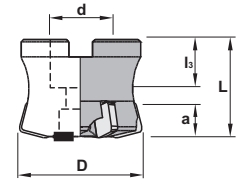
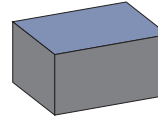
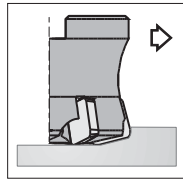

## 1440.90

Ref.		D	D <sub>2</sub>	L	d	l <sub>3</sub>	a	Insert size	
1440.90.050	5	50	56	40	22	20	9	SP.. 1203..	0,300
1440.90.063	5	63	69	50	27	22	9	SP.. 1203..	0,700
1440.90.080	6	80	86	50	32	25	9	SP.. 1203..	1,100
1440.90.100	7	100	106	50	40	29	9	SP.. 1203..	1,800

Ref.						
1440.90.050	6226	1266	1630	5615	3012	912,11
1440.90.063	6226	1266	1630	5615	3012	912,12
1440.90.080	6226	1266	1630	5615	3012	912,17
1440.90.100	6226	1266	1630	5615	3012	912,20

Ref.	SP..	l	s	d	Positive 11° clearance - Square inserts.
	SP.. 1203..	12,70	3,18	12,70	
For more information see page: A.19					
	SPKN-L	SPUN			

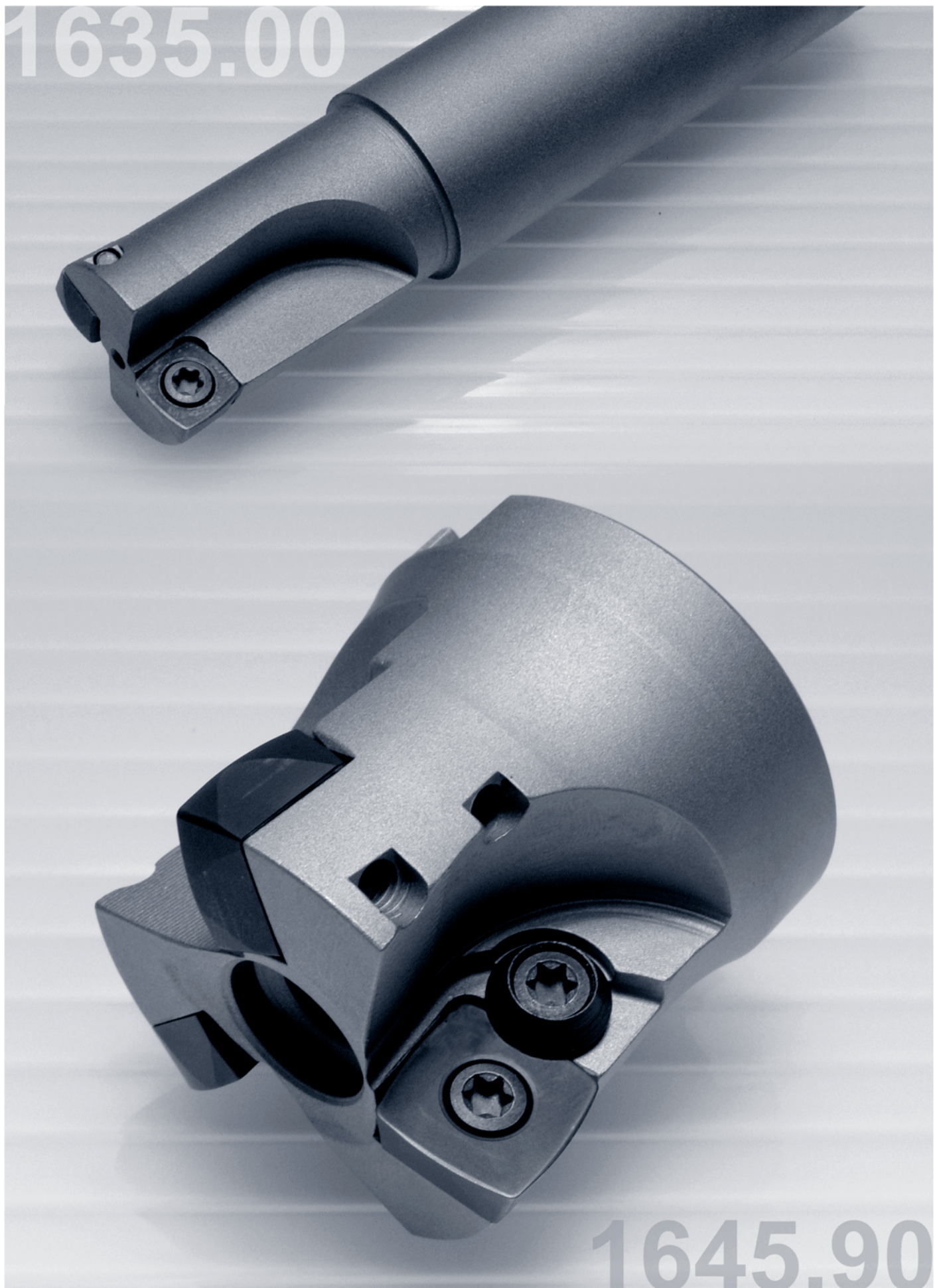

Profile milling
Solid carbide
Drills
Boring heads
Arbors and adaptors

## Processing by direct milling is also possible

Since the cutting flute do not extend to the center, there are limitations on the ramp angle and hole diameter, but as shown below, processing by direct milling without a pilot hole is possible for ramping and helical milling.

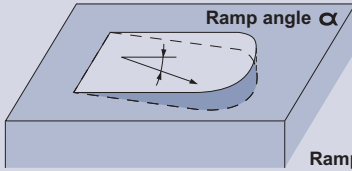

**Ramping**

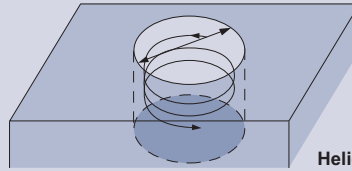

**Helical milling**

Tool diameter	Ø32	Ø40	Ø50	Ø63	Ø80	Ø100
Maximum ramp angle $\alpha$	7°	4,5°	3°	1,7°	1°	1°
Hole diameter	Ø44-61	Ø61-76	Ø80-96	Ø107-122	Ø142-156	Ø179-195

Note -The ramp angle  $\alpha$  should be set within the ranges listed above. Use at ramp angles of 1° or less recommended.  
 -For hole diameters outside the ranges listed above, a pilot hole should be drilled before milling.

## Method for defining conditions of insert tip programmatically

For roughing processing, please create a program with corner R values close to those shown as references below.

**When corner R is set to 4,5**

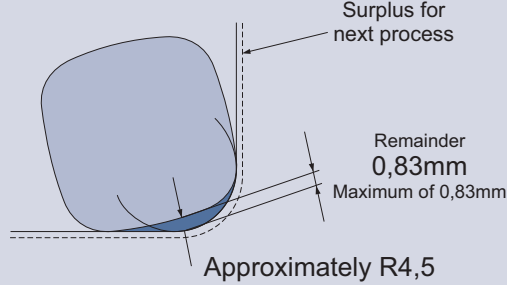

**When corner R is set larger**

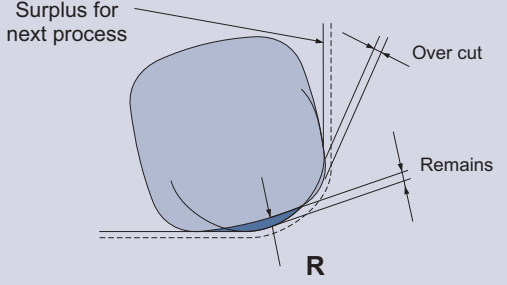

Normally, you should create a program with an input corner R of approximately 4,5. At an approximate input corner R of 4,5, there is no overcutting.

Although overcutting occurs when the approximate R is set to higher values, if the overcutting is within the surplus for the next process, there is no problem with the processing shape and the amount of remainder can be suppressed.

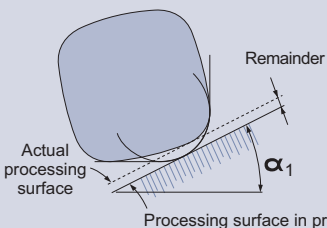

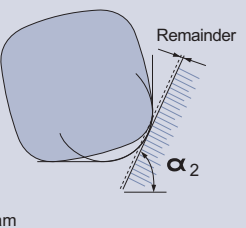

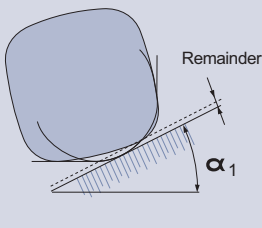

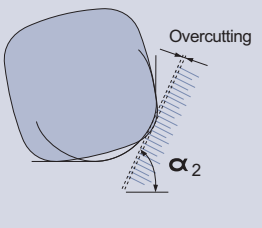

Approximate input corner R	R4,5	R5,1	R5,5	R5,8	R6,1	R6,4
Remainder	0,83 $\alpha_1=22,1^\circ$	0,66 $(\alpha_1=20,3^\circ)$	0,55 $(\alpha_1=19^\circ)$	0,47 $(\alpha_1=17,9^\circ)$	0,39 $(\alpha_1=16,7^\circ)$	0,32 $(\alpha_1=15,4^\circ)$
Overcutting	-	0,1 $(\alpha_2=73,4^\circ)$	0,2 $(\alpha_2=67,7^\circ)$	0,3 $(\alpha_2=64,7^\circ)$	0,4 $(\alpha_2=62,3^\circ)$	0,5 $(\alpha_2=60,5^\circ)$

Note  
 - Overcutting and remainder vary according to the processing shape. The values in the table above are maximum values.  
 - The values of  $\alpha$  shown are the slopes of the processing surfaces when overcutting and remainder are at their maximum respective values.

**For example, when a program is created with an approximate R of 5,1:**  
 Remainder of around 0,66mm is left when the slope of the processing surface is approximately 20,3°, and when the slope of the processing surface is approximately 73,4°, about 0,1mm of overcutting occurs. At areas with other slopes, the overcutting and remainder values are below these values.

## Recommended cutting conditions

Material	Cutting speed Vc (m/min)	Per-flute feed rate fz (mm/tooth)	Ø32 (2 flutes)			Ø40 (3 flutes)			Ø50 (4 flutes)		
			Rotation speed min <sup>-1</sup>	Feed rate mm/min	Q value cm <sup>3</sup> /min	Rotation speed min <sup>-1</sup>	Feed rate mm/min	Q value cm <sup>3</sup> /min	Rotation speed min <sup>-1</sup>	Feed rate mm/min	Q value cm <sup>3</sup> /min
General Structural Steels (200 HB)	180-200	0,6-1,5	1790	5370	171	1430	6400	256	1150	6900	510
				Vc=180m/min fz=1,5mm/tooth ap=1,0mm ae=1,0D			Vc=180 fz=1,5 ap=1,5 ae=1,0				
	90-150	0,6-2,0	895	2690	86	720	3240	130	570	3420	257
				Vc=90m/min fz=1,5mm/tooth ap=1,0mm ae=1,0D			Vc=90 fz=1,5 ap=1,5 ae=1,0				
Carbon Steels Alloy Steels (30 HRC)	180-200	0,6-1,5	1790	5370	171	1430	6400	256	1150	6900	510
				Vc=180m/min fz=1,5mm/tooth ap=1,0mm ae=1,0D			Vc=180 fz=1,5 ap=1,5 ae=1,0				
	90-150	0,6-2,0	895	2690	86	720	3240	130	570	3420	257
				Vc=90m/min fz=1,5mm/tooth ap=1,0mm ae=1,0D			Vc=90 fz=1,5 ap=1,5 ae=1,0				
Carbon Steels Alloy Steels (30-45 HRC)	80-120	0,4-0,8	895	1430	45	720	1730	69	570	1820	130
			Vc=90m/min fz=0,8mm/tooth ap=1,0mm ae=1,0D			Vc=90 fz=0,8 ap=1,5 ae=1,0					
Alloy Steels (45-50 HRC)	70-120	0,02-0,6	995	600	19	790	710	28	630	760	38
			Vc=100m/min fz=0,3mm/tooth ap=1,0mm ae=1,0D			Vc=100 fz=0,3 ap=1,0 ae=1,0					
			700	280	9	550	330	13	440	360	18
Alloy Steels(50-55 HRC)	70-100	0,05-0,2	Vc=70m/min fz=0,2mm/tooth ap=0,5mm ae=1,0D			Vc=70 fz=0,2 ap=1,0 ae=1,0					
			700	280	5	550	330	7	440	350	9
Alloy Steels(55-60 HRC)	50-100	0,05-0,2	Vc=70m/min fz=0,2mm/tooth ap=1,0mm ae=1,0D			Vc=70 fz=0,2 ap=0,5 ae=1,0					
			500	50	0,8	400	60	1	310	62	1,5
Cast Iron	180-200	0,8-2,0	1790	7160	344	1430	8580	515	1150	9200	920
			Vc=180m/min fz=2,0mm/tooth ap=1,5mm ae=1,0D			Vc=180 fz=2,0 ap=2,0 ae=1,0					
			895	3580	172	720	4320	259	570	4560	456
	90-150		Vc=90m/min fz=2,0mm/tooth ap=1,5mm ae=1,0D			Vc=90 fz=2,0 ap=2,0 ae=1,0					

Material	Cutting speed Vc (m/min)	Per-flute feed rate fz (mm/tooth)	Ø63 (4 flutes)			Ø80 (5 flutes)			Ø100 (6 flutes)		
			Rotation speed min <sup>-1</sup>	Feed rate mm/min	Q value cm <sup>3</sup> /min	Rotation speed min <sup>-1</sup>	Feed rate mm/min	Q value cm <sup>3</sup> /min	Rotation speed min <sup>-1</sup>	Feed rate mm/min	Q value cm <sup>3</sup> /min
General Structural Steels (200 HB)	180-200	0,6-1,5	910	5500	520	720	5400	650	570	5130	770
				Vc=180m/min fz=1,5mm/tooth ap=1,5mm ae=1,0D			Vc=180 fz=1,5 ap=1,5 ae=1,0D				
	90-150	0,6-2,0	455	2730	258	360	2700	325	290	2610	390
				Vc=90m/min fz=1,5mm/tooth ap=1,5mm ae=1,0D			Vc=90 fz=1,5 ap=1,5 ae=1,0D				
Carbon Steels Alloy Steels (30 HRC)	180-200	0,6-1,5	910	5500	520	720	5400	650	570	5130	770
				Vc=180m/min fz=1,5mm/tooth ap=1,5mm ae=1,0D			Vc=180 fz=1,5 ap=1,5 ae=1,0D				
	90-150	0,6-2,0	455	2730	258	360	2700	325	290	2610	390
				Vc=90m/min fz=1,5mm/tooth ap=1,5mm ae=1,0D			Vc=90 fz=1,5 ap=1,5 ae=1,0D				
Carbon Steels Alloy Steels (30-45 HRC)	80-120	0,4-0,8	455	1450	140	360	1440	170	290	1400	210
			Vc=90m/min fz=0,8mm/tooth ap=1,5mm ae=1,0D			Vc=90 fz=0,8 ap=1,5 ae=1,0D					
Alloy Steels (45-50 HRC)	70-120	0,02-0,6	500	600	38	400	600	48	320	576	58
			Vc=100m/min fz=0,3mm/tooth ap=1,0mm ae=1,0D			Vc=100 fz=0,3 ap=1,0 ae=1,0D					
			350	280	18	280	280	22	220	260	26
Alloy Steels(50-55 HRC)	70-100	0,05-0,2	Vc=70m/min fz=0,2mm/tooth ap=1,0mm ae=1,0D			Vc=70 fz=0,2 ap=1,0 ae=1,0D					
			350	280	9	270	270	11	220	260	13
Alloy Steels(55-60 HRC)	50-100	0,05-0,2	Vc=70m/min fz=0,2mm/tooth ap=0,5mm ae=1,0D			Vc=70 fz=0,2 ap=0,5 ae=1,0D					
			250	50	1,5	200	50	2,0	160	48	2,4
Cast Iron	180-200	0,8-2,0	910	7280	920	720	7200	1150	570	6840	1370
			Vc=180m/min fz=2,0mm/tooth ap=2,0mm ae=1,0D			Vc=180 fz=2,0 ap=2,0 ae=1,0D					
			455	3640	459	360	3600	576	290	3840	696
	90-150		Vc=90m/min fz=2,0mm/tooth ap=2,0mm ae=1,0D			Vc=90 fz=2,0 ap=2,0 ae=1,0D					

Note

- Select the best cutting condition when working, referring to above list.  
(If the overhang is 3D or less, the recommended cutting speed is  
Vc=180-200m/min; 3D or more: Vc=90-130m/min.)

- Thick and heavy chips are generated by using this tool. Be sure to remove them with air blow in order to avoid any breakage by blocking with chips.

The recommended method is "Spindle center through" when blowing air. (Pay attention when removing chips in cavity work with the machining center <vertical type>.)

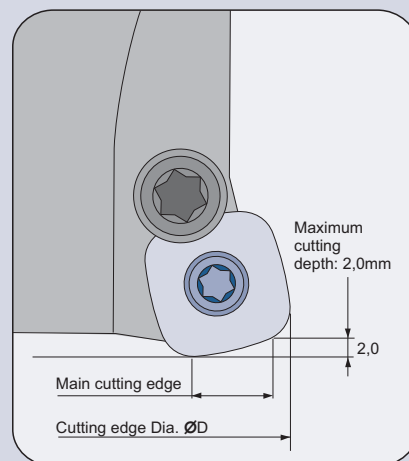

Inserts

Face milling cutters

Square shoulder cutters

Slot cutters

Porcupine cutters

Specific applications and Sets

Profile milling



### Characteristics:

Round insert end mills for slot milling, peripheral milling, ramp milling and drilling, pocket milling and copy milling. Precision type inserts are available for efficient machining in most materials. Milling cutter equipped with cylindrical shank.

### Applications:

This copying milling cutter works well on hard steels, alloyed steels, stainless steels, refractory casts and aluminium alloys. A general milling cutter for diversified manufacture that allows using it in only one pass (roughing and finishing) and it is recommended for conventional milling machines and machining centers.

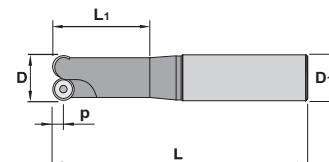
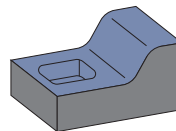
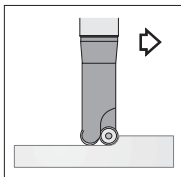

## 55\_5

Ref.		D	L	D1	L1	p	Insert size	
5525.00.015	2	15	100	20	40	3,5	RD.. 0702M0	0,180
5525.01.015	2	15	150	20	40	3,5	RD.. 0702M0	0,300
5525.00.016	2	16	100	20	40	3,5	RD.. 0702M0	0,185
5525.01.016	2	16	150	20	40	3,5	RD.. 0702M0	0,310
5535.00.020	2	20	100	20	40	5,0	RD.. 1003M0	0,220
5535.01.020	2	20	150	20	40	5,0	RD.. 1003M0	0,340
5545.00.025	2	25	125	25	50	6,0	RD.. 12T3M0	0,460
5545.01.025	2	25	180	25	60	6,0	RD.. 12T3M0	0,670
5545.00.032	3	32	125	32	50	6,0	RD.. 12T3M0	0,740
5545.01.032	3	32	180	32	60	6,0	RD.. 12T3M0	1,080
5555.01.032	2	32	180	32	60	8,0	RD.. 1604M0	1,080

Ref.		
5525.00.015	1425	5507
5525.01.015	1425	5507
5525.00.016	1425	5507
5525.01.016	1425	5507
5535.00.020	1435	5515
5535.01.020	1435	5515
5545.00.025	1435	5515
5545.01.025	1435	5515
5545.00.032	1435	5515
5545.01.032	1435	5515
5555.01.032	1445	5515

Ref.	RD..			Positive 15° clearance - Round insert.
	l	s	d	
RD.. 0702M0	-	2,38	7,00	
RD.. 1003M0	-	3,18	10,00	
RD.. 12T3M0	-	3,97	12,00	
RD.. 1604M0	-	4,76	16,00	
	RDHW	RDMT	RDMW	

For more information see page: A.15



Shanks page: K.45 - K.48

**Characteristics:**

Round insert end mills for slot milling, peripheral milling, ramp milling and drilling, pocket milling and copy milling. Precision type inserts are available for efficient machining in most materials. Milling cutter equipped with cylindric shank.

**Applications:**

This copying milling cutter works well on hard steels, alloyed steels, stainless steels, refractory casts and aluminium alloys. A generalmilling cutter for diversified manufacture that allows using it in only one pass (roughing and finishing) and it is recommended for conventional milling machines and machining centers.

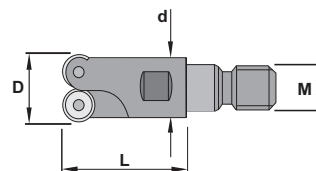
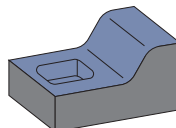
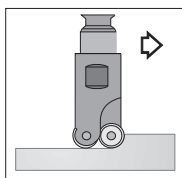

55_5.06			D	L	M	d	Insert size	
Ref.	5525.06.016	2	16	23	M8	14	RD.. 0702..	0,030
	5535.06.020	2	20	30	M10	18	RD.. 1003..	0,060
	5535.06.025	3	25	35	M12	21	RD.. 1003..	0,095
	5535.06.035	4	35	43	M16	29	RD.. 1003..	0,225
	5535.06.042	5	42	43	M16	29	RD.. 1003..	0,320
	5545.06.025	2	25	43	M12	21	RD.. 12T3..	0,095
	5545.06.032	3	32	43	M16	29	RD.. 12T3..	0,230
	5545.06.035	3	35	43	M16	29	RD.. 12T3..	0,250
	5545.06.042	4	42	43	M16	29	RD.. 12T3..	0,320
	5545.06.042Z=5	5	42	43	M16	29	RD.. 12T3..	0,320
	5555.06.032	2	32	43	M16	29	RD.. 1604..	0,250

Ref.		
5525.06.016	1425	5507
5535.06.020	1435	5515
5535.06.025	1435	5515
5535.06.035	1435	5515
5535.06.042	1435	5515
5545.06.025	1435	5515
5545.06.032	1435	5515
5545.06.035	1435	5515
5545.06.042	1435	5515
5545.06.042Z=5	1435	5515
5555.06.032	1445	5515

Ref.	RD..			Positive 15° clearance - Round insert.
	l	s	d	
RD..0702M0	-	2,38	7,00	For more information see page: A.15
RD..1003M0	-	3,18	10,00	
RD..12T3M0	-	3,97	12,00	
RD..1604M0	-	4,76	16,00	
	RDHW	RDMT	RDMW	

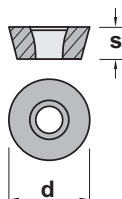

Profile milling  
Solid carbide  
Drills  
Boring heads  
Arbors and adaptors

Inserts

Face milling cutters

Square shoulder cutters

Slot cutters

Porcupine cutters

Specific applications and Sets

Profile milling



### Characteristics:

Round insert end mills for slot milling, peripheral milling, ramp milling and drilling, pocket milling and copy milling. Precision type inserts are available for efficient machining in most materials.

### Applications:

This copying milling cutter works well on hard steels, alloyed steels, stainless steels, refractory casts and aluminium alloys. A general milling cutter for diversified manufacture that allows using it in only one pass (roughing and finishing) and it is recommended for conventional milling machines and machining centers.

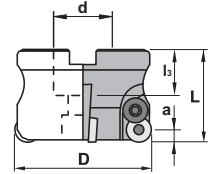
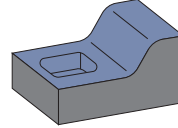
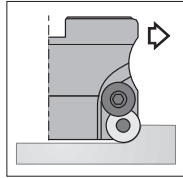

## 55<sup>4</sup><sub>5</sub> 5.90

Ref.		D	L	d	ls	a	Insert size	
5545.90.052	5	52	50	22	20	6	RD.. 12T3..	0,450
5545.90.066	6	66	50	27	22	6	RD.. 12T3..	0,770
5545.90.080	7	80	50	27	22	6	RD.. 12T3..	1,200
5555.90.052	4	52	50	22	20	8	RD.. 1604..	0,350
5555.90.066	5	66	50	27	22	8	RD.. 1604..	0,700
5555.90.080	6	80	50	27	22	8	RD.. 1604..	1,050
5555.90.100	7	100	55	32	25	8	RD.. 1604..	1,800
5555.90.125	8	125	55	40	30	8	RD.. 1604..	3,500
5555.90.160	9	160	55	40	30	8	RD.. 1604..	5,600

Ref.				
5545.90.052	1235	2009	912,10	5615
5545.90.066	1235	2009	912,12	5615
5545.90.080	1235	2009	912,12	5615
5555.90.052	1245	2010	912,10	5615
5555.90.066	1245	2010	912,12	5615
5555.90.080	1245	2010	912,12	5615
5555.90.100	1245	2010	912,17	5615
5555.90.125	1245	2010	-	5615
5555.90.160	1245	2010	912,52	5615

		RD..			Positive 15° clearance - Round insert.
Ref.		l	s	d	
	RD.. 12T3M0	-	3,97	12,00	
	RD.. 1604M0	-	4,76	16,00	
					For more information see page: A.15
RDHW	RDMT	RDMW			



**Characteristics:**

Round insert end mills for slot milling, peripheral milling, ramp milling and drilling, pocket milling and copy milling. Precision type inserts are available for efficient machining in most materials.

**Applications:**

This copying milling cutter works well on hard steels, alloyed steels, stainless steels, refractory casts and aluminium alloys. A general milling cutter for diversified manufacture that allows using it in only one pass (roughing and finishing) and it is recommended for conventional milling machines and machining centers.

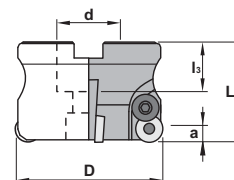
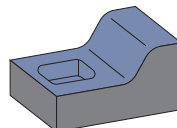
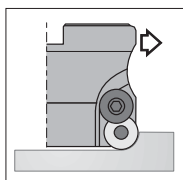

# 5549.90

Ref.		D	L	d	l3	a	Insert size	
5549.90.040	3	40	40	16	18	6	RPM.. 1204M0	0,200
5549.90.050	4	50	40	22	20	6	RPM.. 1204M0	0,300
5549.90.063	5	63	50	27	22	6	RPM.. 1204M0	0,650
5549.90.080	6	80	50	32	25	6	RPM.. 1204M0	1,150
5549.90.100	7	100	50	40	30	6	RPM.. 1204M0	1,750
5549.90.125	7	125	63	40	30	6	RPM.. 1204M0	3,100
5549.90.160	8	160	63	40	30	6	RPM.. 1204M0	4,100

Ref.						
5549.90.040	1025	5003	1240	5615	1058	-
5549.90.050	1025	5003	1240	5615	912,10	-
5549.90.063	1025	5003	1240	5615	912,12	-
5549.90.080	1025	5003	1240	5615	912,17	-
5549.90.100	1025	5003	1240	5615	912,20	-
5549.90.125	1025	5003	1240	5615	-	-
5549.90.160	1025	5003	1240	5615	912,52	40

RPM..		l	s	d	Positive 11° clearance - Round inserts.
Ref.	RPM.. 1204M0	-	4,76	12,00	
For more information see page: A.15					
RPMT	RPMW				

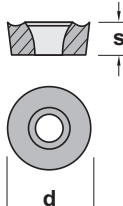

Profile milling  
Solid carbide  
Drills  
Boring heads  
Arbors and adaptors

## Recommended cutting conditions

Material	m/min Cutting Speed	mm/tooth Feed rate	Ø12 - Ø20			Ø24 - Ø25			Ø32 - Ø35		
			min <sup>-1</sup>	mm/min	cm <sup>3</sup> /min	min <sup>-1</sup>	mm/min	cm <sup>3</sup> /min	min <sup>-1</sup>	mm/min	cm <sup>3</sup> /min
Mild Steels (200 HB)	150-250	0,3-0,8	3980	3180	28,6	3180	2540	28,6	2490	2990	43,1
			Vc=250m/min fz=0,4mm/tooth ap=1,5mm ae=0,3D								
			3980	3180	47,7	3180	2540	47,6	2490	2990	71,8
Carbon Steels Alloy Steels (30 HRC)	120-230	0,3-0,8	3180	2540	22,9	2550	2040	23	1990	2390	34,4
			Vc=200m/min fz=0,4mm/tooth ap=1,5mm ae=0,3D								
			3180	2540	38,1	2550	2040	38,3	1990	2390	57,4
Carbon Steels Alloy Steels (30-40 HRC)	100-200	0,2-0,6	2390	960	8,6	1910	760	8,6	1490	890	12,8
			Vc=150m/min fz=0,2mm/tooth ap=1,5mm ae=0,3D								
			2390	1430	21,5	1910	1150	21,6	1490	1340	32,2
Carbon Steels Alloy Steels (40-45 HRC)	60-150	0,15-0,3	1590	480	2,9	1270	380	2,9	990	450	4,3
			Vc=100m/min fz=0,15mm/tooth ap=1mm ae=0,3D								
			1590	640	6,4	1270	510	6,4	990	590	9,4
Carbon Steels Alloy Steels (45-50 HRC)	60-100	0,15-0,3	1270	380	2,3	1020	310	2,3	800	360	3,5
			Vc=80m/min fz=0,15mm/tooth ap=1mm ae=0,3D								
			1270	380	3,8	1020	310	3,9	800	360	5,8
Alloy Steels (50-60 HRC)	50-100	0,05-0,2	1110	220	1,3	890	170	1,2	690	200	1,9
			Vc=70m/min fz=0,1mm/tooth ap=1mm ae=0,3D								
			1110	220	2,2	890	170	2,1	690	200	3,2
Stainless Steels	150-240	0,2-0,8	3180	1590	14,3	2550	1280	14,4	1990	1490	21,5
			Vc=200m/min fz=0,25mm/tooth ap=1,5mm ae=0,3D								
			2860	1716	25,7	2290	1370	25,7	1790	1610	38,6
Cast Iron	100-220	0,3-1,0	2860	2290	20,6	2290	1830	20,6	1790	2150	31
			Vc=180m/min fz=0,4mm/tooth ap=1,5mm ae=0,3D								
			2860	2860	42,9	2290	2290	42,9	1790	2690	64,6
Vc=180m/min fz=0,5mm/tooth ap=1,5mm ae=0,5D											

Material	Ø40 - Ø42 (R6)			Ø50 - Ø52 ( R6)			Ø40 - Ø42 (R8)			Ø50 - Ø52 ( R8)		
	min <sup>-1</sup>	mm/min	cm <sup>3</sup> /min	min <sup>-1</sup>	mm/min	cm <sup>3</sup> /min	min <sup>-1</sup>	mm/min	cm <sup>3</sup> /min	min <sup>-1</sup>	mm/min	cm <sup>3</sup> /min
Mild Steels (200 HB)	1990	2990	71,8	1590	3180	95,4	1990	1990	47,8	1590	2390	71,7
	Vc=250m/min fz=0,5mm/tooth ap=2mm ae=0,3D											
	1990	4780	191,2	1590	5090	254,5	1990	3180	159	1590	3820	238,8
Carbon Steels Alloy Steels (30 HRC)	1590	1910	45,8	1270	2030	60,9	1590	1270	30,5	1270	1520	45,6
	Vc=200m/min fz=0,4mm/tooth ap=2mm ae=0,3D											
	1590	2860	114,4	1270	3050	152,5	1590	1910	95,5	1270	2290	143,1
Carbon Steels Alloy Steels (30-40 HRC)	1190	710	17	960	770	23,1	1190	480	11,5	960	580	17,4
	Vc=150m/min fz=0,2mm/tooth ap=2mm ae=0,3D											
	1190	1070	42,8	960	1150	57,5	1190	950	47,5	960	1150	71,9
Carbon Steels Alloy Steels (40-45 HRC)	800	360	6,5	640	380	8,6	800	240	4,3	640	290	6,5
	Vc=100m/min fz=0,15mm/tooth ap=1,5mm ae=0,3D											
	800	480	14,4	640	510	19,1	800	320	12,8	640	380	19
Carbon Steels Alloy Steels (45-50 HRC)	640	290	3,5	510	310	4,7	640	220	4	510	260	5,9
	Vc=80m/min fz=0,15mm/tooth ap=1mm ae=0,3D											
	640	330	6,6	510	350	8,8	640	260	7,8	510	310	11,6
Alloy Steels (50-60 HRC)	550	160	1,9	440	170	2,5	550	110	1,3	440	130	1,9
	Vc=70m/min fz=0,1mm/tooth ap=1mm ae=0,3D											
	550	160	3,2	440	170	4,2	550	110	2,2	440	130	3,2
Stainless Steels	1590	1430	34,3	1270	1520	45,6	1590	950	22,8	1270	1140	34,2
	Vc=200m/min fz=0,3mm/tooth ap=2mm ae=0,3D											
	1430	2150	86	1150	2300	115	1430	1720	86	1150	2070	129,4
Cast Iron	1430	2150	51,6	1150	2300	69	1430	1430	34,3	1150	1730	51,9
	Vc=180m/min fz=0,5mm/tooth ap=2mm ae=0,3D											
	1430	3430	137,2	1150	3680	184	1430	2290	114,5	1150	2760	172,5
Vc=180m/min fz=0,8mm/tooth ap=2mm ae=0,5D												

Note

-In this table, cutting conditions indicate regular type conditions for frank wear to be 0,3mm in 30 minutes.

-The following formula shows the chip removal volume (Q) per unit time.

$$Q(\text{cm}^3/\text{min}) = a_p(\text{mm}) \times a_e(\text{mm}) \times V_f(\text{mm}/\text{min}) / 1000$$

-In the case of slotting, feed speed could be down to 70% of the whole.

-This table shows starting points of general cutting conditions. Please adjust according to rigidity of machine tools, tooling, conditions of work-pieces and so on.

-In steel exceeding 60HRC, such as dice steel between the colds, please set the sending (fz) value per one edge about 1/2.

## Recommended cutting conditions

Material	m/min Cutting Speed	mm/tooth Feed rate	Ø63 ( R6)			Ø80 ( R6)			Ø100 ( R6)		
			min <sup>-1</sup>	mm/min	cm <sup>3</sup> /min	min <sup>-1</sup>	mm/min	cm <sup>3</sup> /min	min <sup>-1</sup>	mm/min	cm <sup>3</sup> /min
Mild Steels (200 HB)	150-250	0,3-0,8	3780	142,9	-	-	-	-	-	-	-
			Vc=250m/min fz=0,5mm/tooth ap=2mm ae=0,3D								
			1260	6050	381,2	1000	4800	384	800	3200	320
Carbon Steels Alloy Steels (30 HRC)	120-230	0,3-0,8	1010	2420	91,5	-	-	-	-	-	-
			Vc=200m/min fz=0,4mm/tooth ap=2mm ae=0,3D								
			1010	3640	229,3	800	2880	230,4	640	1920	192
Carbon Steels Alloy Steels (30-40 HRC)	100-200	0,2-0,6	760	910	34,4	-	-	-	-	-	-
			Vc=150m/min fz=0,2mm/tooth ap=2mm ae=0,3D								
			760	1370	86,3	600	1080	86,4	480	720	72
Carbon Steels Alloy Steels (40-45 HRC)	60-150	0,15-0,3	510	460	13	-	-	-	-	-	-
			Vc=100m/min fz=0,15mm/tooth ap=1,5mm ae=0,3D								
			510	610	28,8	400	480	28,8	320	320	24
Carbon Steels Alloy Steels (45-50 HRC)	60-100	0,15-0,3	400	360	6,8	-	-	-	-	-	-
			Vc=80m/min fz=0,15mm/tooth ap=1mm ae=0,3D								
			400	410	12,9	320	330	13,2	250	210	10,5
Alloy Steels (50-60 HRC)	50-100	0,05-0,2	350	210	3,9	270	160	3,8	220	110	3,3
			Vc=70m/min fz=0,1mm/tooth ap=1mm ae=0,3D								
			350	210	6,6	270	160	6,4	220	110	5,5
Stainless Steels	150-240	0,2-0,8	1010	1820	68,8	-	-	-	-	-	-
			Vc=200m/min fz=0,3mm/tooth ap=2mm ae=0,3D								
			910	2730	172	720	2160	172,8	570	1430	143
Cast Iron	100-220	0,3-1,0	910	2730	103,2	-	-	-	-	-	-
			Vc=180m/min fz=0,5mm/tooth ap=2mm ae=0,3D								
			910	4370	275,3	720	3460	276,8	570	2280	228
Vc=180m/min fz=0,8mm/tooth ap=2mm ae=0,5D											

## Field Data

### Ramping, Helical Milling, Feeding toward Z-AXIS

There are restrictions to Ramp angle ( $\alpha$ ) and cutting depth (g) toward Z-axis because of designs of cutting edge.

Ramping

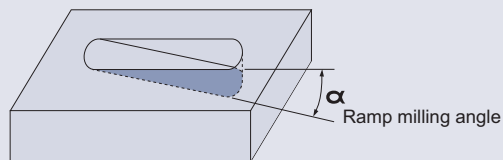

Helical milling

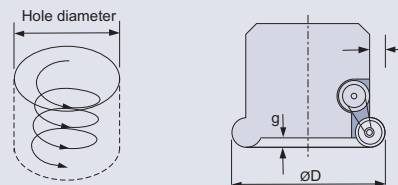

ØD	Ø40	Ø50 - Ø52	Ø63 - Ø66	Ø80	Ø100	Ø125 - Ø160
Recommended $\alpha$	Below 3 degrees					Below 2 degrees
h	2,5	2,5	2,5	2,5	2,5	2,5
g	3,7	3,3	5,5	5,5	5,5	5,5
Helical hole diameter	60-78	77-100	101-124	135-158	175-198	248-255

Note

-Chips may be shattered. The wearing of safety glasses and the guard are required in the vicinity of machining.

Inserts

Face milling cutters

Square shoulder cutters

Slot cutters

Porcupine cutters

Specific applications and Sets

Profile milling



Shanks page: K.45 - K.48

**Characteristics:**

General application end mills for slot milling, peripheral milling, ramp milling and drilling, pocket milling and copy milling. Precision type inserts are available for efficient machining aluminium alloys.

Milling cutter equipped with modular shank.

**Applications:**

Aluminium plastics and exotic materials machining.

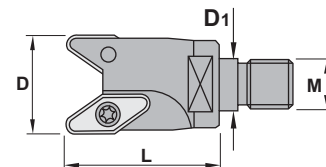
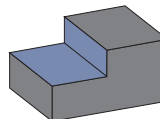
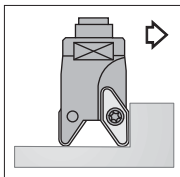

## 0344.06

Ref.		D	L	M	D1	Insert size	
0344.06.015	2	15	35	M8	8,5	VCGT 1103..	0,040
0344.06.020	2	20	35	M10	10,5	VCGT 1103..	0,070
0344.06.025	2	25	50	M12	12,5	VCGT 1604..	0,110
0344.06.032	2	32	50	M16	17,0	VCGT 2205..	0,240
0344.06.042	3	42	50	M16	17,0	VCGT 2205..	0,400

Ref.		
0344.06.015	1225	5507
0344.06.020	1225	5507
0344.06.025	1240	5515
0344.06.032	1250	5520
0344.06.042	1250	5520

VCGT		l	s	d	Positive 7° clearance - 35° rhombic inserts
Ref.	VCGT 1103..	11,00	3,18	6,35	
	VCGT 1604..	16,50	4,76	9,52	
	VCGT 2205..	22,10	5,56	12,70	
For more information see page: A.22					
VCGT-AL	VCGT-AP				



**Characteristics:**

General application bottom cutter for slot milling, peripheral milling, ramp milling and drilling, pocket milling and copy milling. Precision type inserts are available for efficient machining aluminium alloys.

**Applications:**

Aluminium plastics and exotic materials machining.

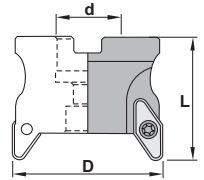
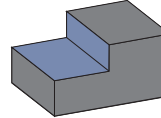
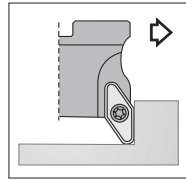

# 0344.90

Ref.		D	d	L	Insert size	
0344.90.042	3	42	16	55	VCGT 2205..	0,180
0344.90.052	3	52	22	55	VCGT 2205..	0,350
0344.90.066	4	66	27	55	VCGT 2205..	0,800
0344.90.080	5	80	27	55	VCGT 2205..	1,150

Ref.		
0344.90.042	1250	5520
0344.90.052	1250	5520
0344.90.066	1250	5520
0344.90.080	1250	5520

VCGT		l	s	d	Positive 7° clearance - 35° rhombic inserts
Ref.	VCGT 2205..	22,10	5,56	12,70	
For more information see page: A.22					
	VCGT-AL				
	VCGT-AP				

Profile milling  
Solid carbide  
Drills  
Boring heads  
Arbors and adaptors

Inserts

Face milling cutters

Square shoulder cutters

Slot cutters

Porcupine cutters

Specific applications and Sets

Profile milling

## Recommended cutting conditions

Material		Cutting Speed	
		ZR 10 Vc (mm/min)	KM 15 Vc (mm/min)
Aluminium alloys	Rm < 280 N/mm <sup>2</sup>	1500	1000
	Rm < 280 N/mm <sup>2</sup>	1000	800
Copper alloys	Long chipping	300	250
Thermoplastics			300
Aluminium alloys	Si < 12 %	100	800
	Si ≥ 12 %	200	
Copper alloys	Short chipping	500	400
Magnesium alloys			400
Duroplastics		200	150

Maximum feed per tooth fz (mm/z) in mm		
VCGT 1103..	VCGT 1604..	VCGT 2205..
0,25	0,35	0,5
0,2	0,3	0,4

## Further application recommendations

### Pocket milling and axial plunging

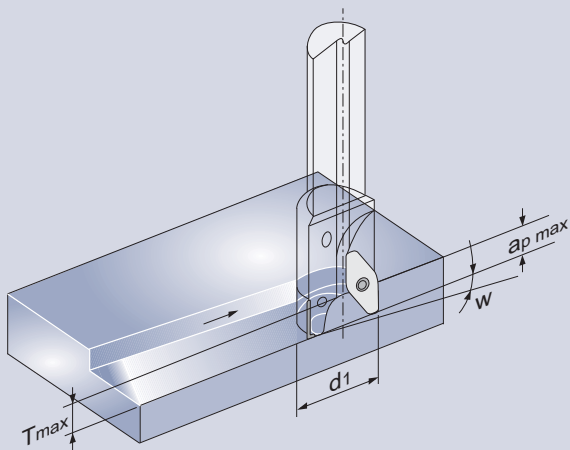

	Helix angle W1 max and internal depth of cut Tmax		
	VCGT 110304-ALM	VCGT 160412-ALM	VCGT 220530-ALM
ap max	10	13,5	15
T max	6	8	9
W1 max in Grad degree			
15			
20	25		
25		24	
32			22
42			15
52			12
66			9
80			7

### Circular milling

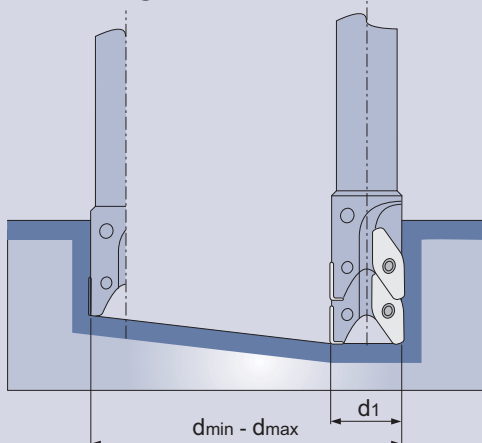

d1 mm	dmin mm	dmax mm
15	15	15
20	20	20
25	25	25
32	32	32
42	42	42
52	52	52
66	66	66
80	80	80

# 0344.90

General application bottom cutter for slot milling, peripheral milling, ramp milling and drilling, pocket milling and copy milling. Precision type inserts are available for efficient machining aluminium alloys.

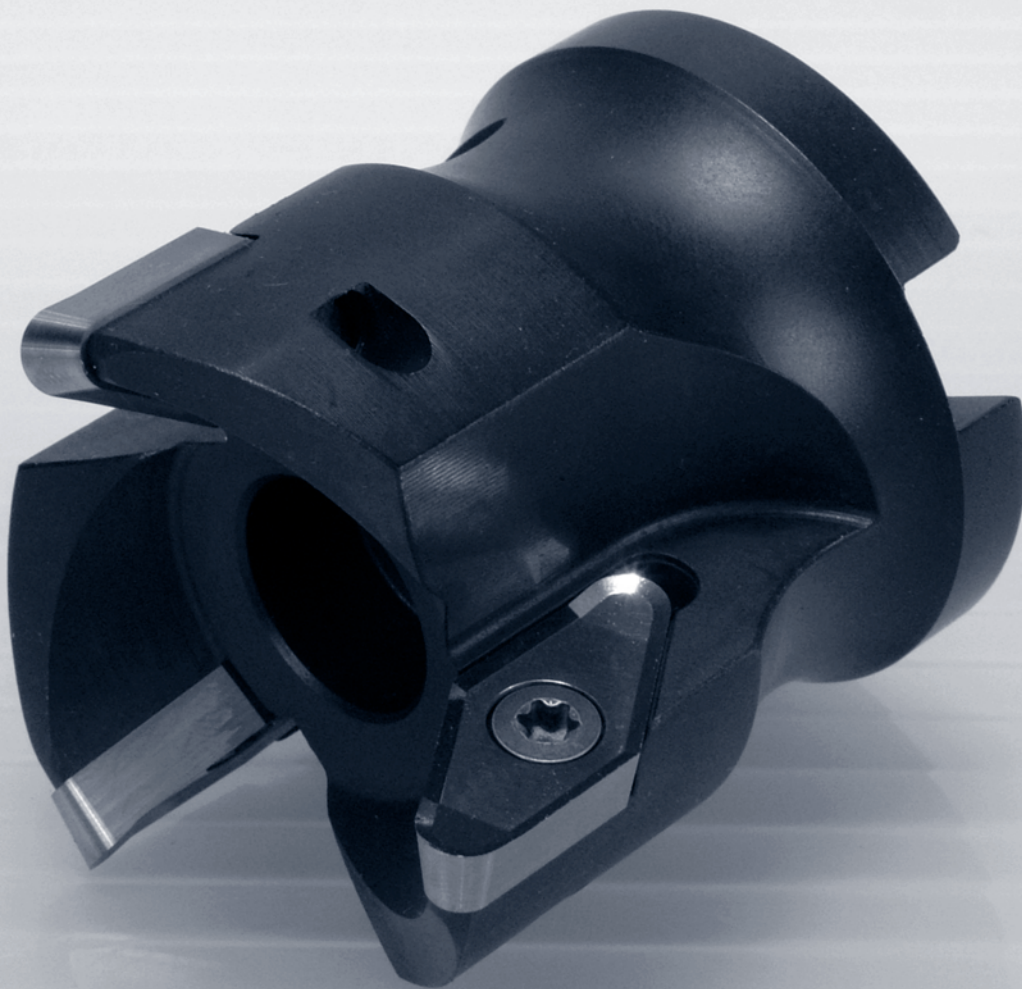

Profile milling

Solid carbide

Drills

Boring heads

Arbors and adaptors