

# Automatic lathes

Inserts

General turning

Aluminium  
wheel turning

Automatic lathes

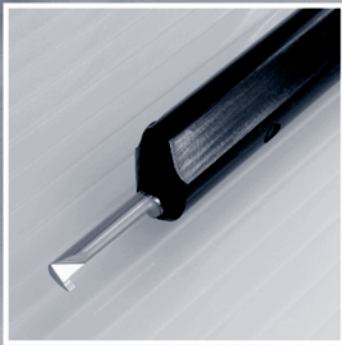
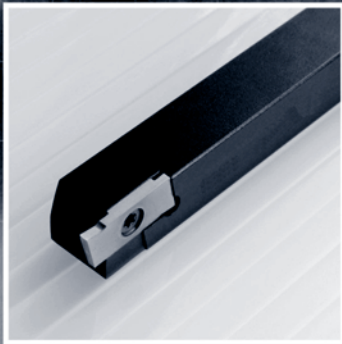
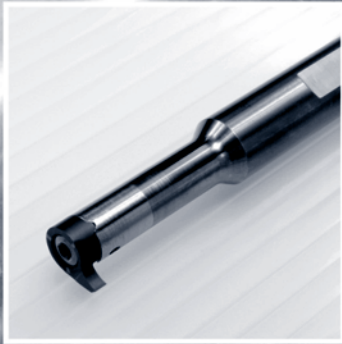
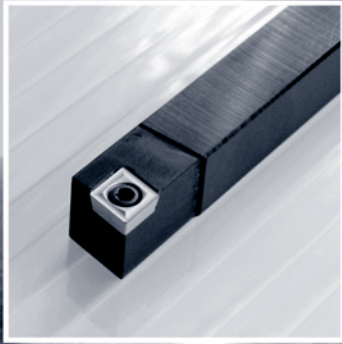

# Automatic lathes

Technical information	E.02
Applications	E.03
Microturn	E.04
Center screw toolholders	E.12
Other applications	E.21
Cutting data	E.23

Automatic lathes

Ceramic tools

Parting and  
grooving

Threading

Drills

Cartridges

Brazed tools

Tooling

<b>S</b>	<b>C</b>	<b>A</b>	<b>C</b>	<b>R</b>	<b>12</b>	<b>12</b>	<b>M</b>	<b>09</b>
<b>1</b>	<b>2</b>	<b>3</b>	<b>4</b>	<b>5</b>	<b>6</b>	<b>7</b>	<b>8</b>	<b>9</b>

**1**

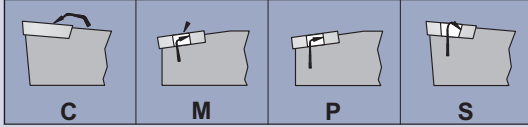

**2**

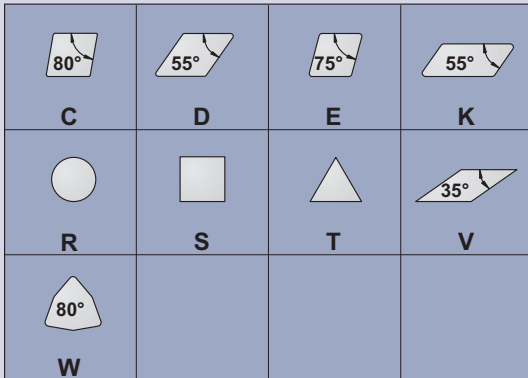

**4**

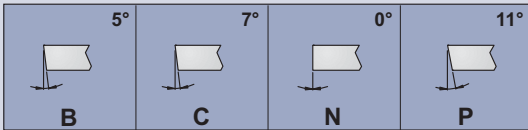

**5**

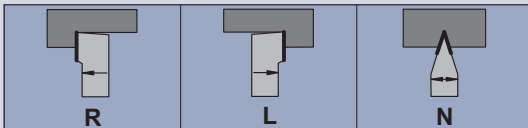

**8**

	Tool length, mm.		D	60	P	170
	E	70	R	200		
	F	80	S	250		
	H	100	T	300		
	K	125	U	350		
	L	140	V	400		
	M	150	X	Special		

**3**

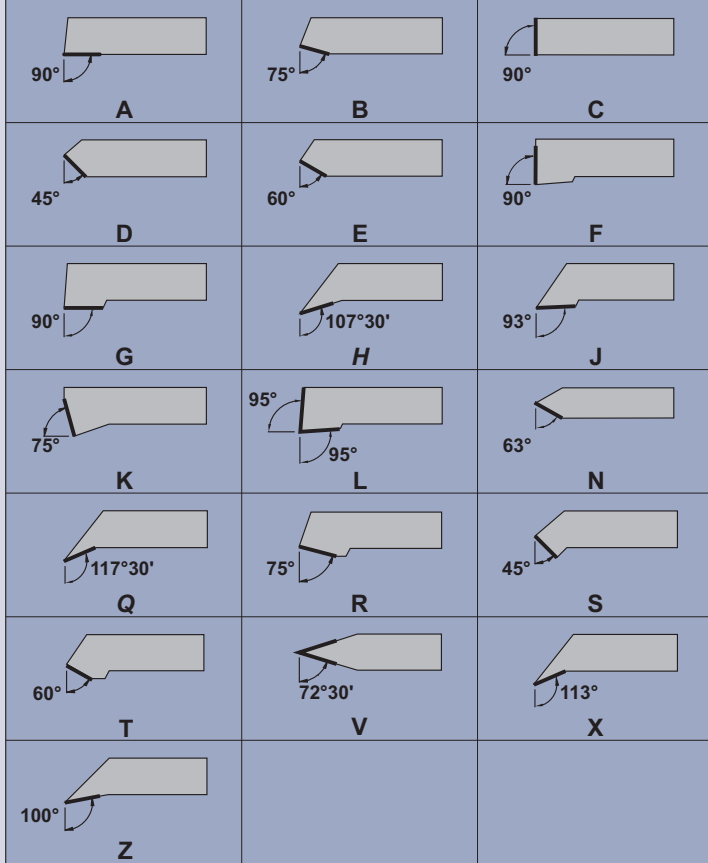

**6**

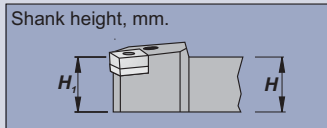

**7**

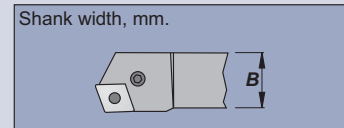

**9**

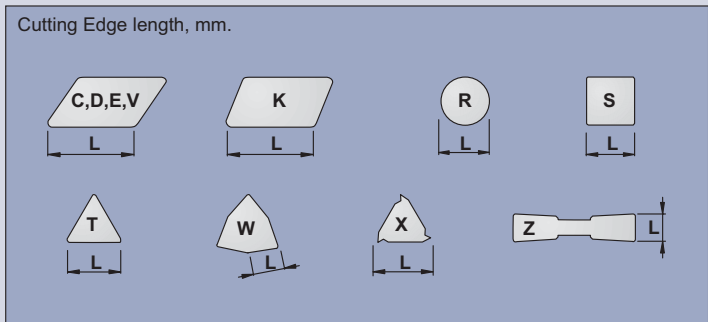

Inserts

General turning

Aluminium wheel turning

Automatic lathes

Microturn

**STHE**



Page E.05

**MT**



Page E.06

**608.00**



Page E.08

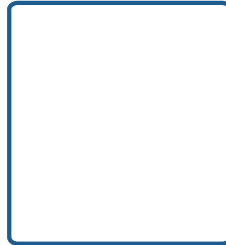
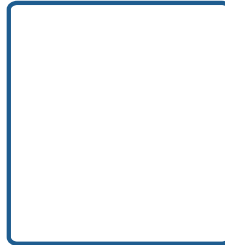

Center screw toolholders

**SCAC 90°**

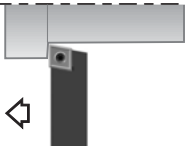

Page E.12 CC.. 0602..  
CC.. 09T3..

**SCLC 95°**

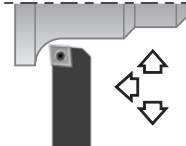

Page E.13 CC.. 0602..  
CC.. 09T3..

**SDAC 90°**

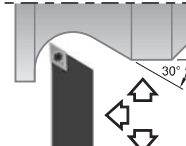

Page E.14 DC.. 0702..  
DC.. 11T3..

**SDJC 93°**

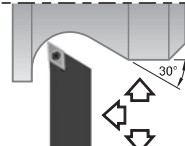

Page E.15 DC.. 0702..  
DC.. 11T3..

**SDNC 63°**

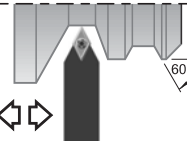

Page E.16 DC.. 0702..  
DC.. 11T3..

**STJC 93°**

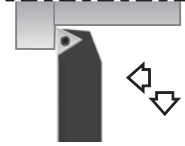

Page E.17 TC.. 1102..

**SVAC 90°**

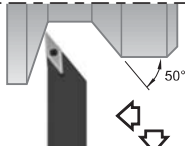

Page E.18 VC.. 1103..  
VC.. 1604..

**SVJC 93°**

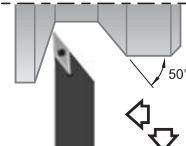

Page E.19 VC.. 1103..  
VC.. 1604..

**SVVC 72°30'**

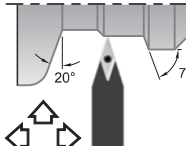

Page E.20 VC..1103..



Other applications

**SXAN 90°**

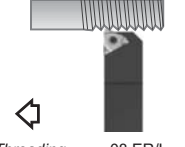

Threading 08 ER/L...  
11 ER/L...  
16 ER/L...  
Page E.21

**CZCB**



MRCN 1,6  
MRCN 2,2  
MRCN 3,0  
Parting and grooving  
Page E.22

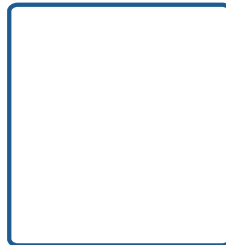
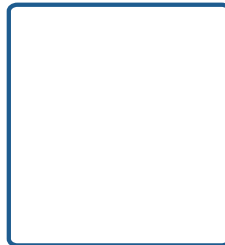

Automatic lathes

Ceramic tools

Parting and grooving

Threading

Drills

Cartridges

Brazed tools

Tooling

Inserts

General turning

Aluminium wheel turning

Automatic lathes

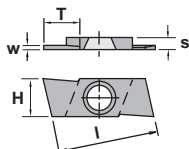
	Standard grooving inserts						Normally available for immediate delivery ● Only available in a limited quantity ○			
	<b>GISG</b>	I	s	H	T	W	KM15	PM25	TIN25	TL20
	<b>GISG05R-L</b>	17,00	2,00	7,00	2,54	0,50			●	
	<b>GISG07R-L</b>	17,00	2,00	7,00	2,54	0,70			●	
	<b>GISG08R-L</b>	17,00	2,00	7,00	2,54	0,80			●	
	<b>GISG09R-L</b>	17,00	2,00	7,00	2,54	0,90			●	
	<b>GISG11R-L</b>	17,00	2,00	7,00	6,00	1,10			●	
	<b>GISG13R-L</b>	17,00	2,00	7,00	6,00	1,30			●	
	<b>GISG16R-L</b>	17,00	2,00	7,00	6,00	1,60			●	
	<b>GISG185R-L</b>	17,00	2,00	7,00	6,00	1,85			●	

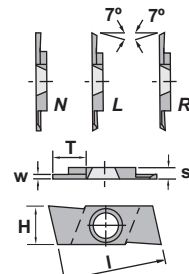
	Grooving and cut-off inserts						Normally available for immediate delivery ● Only available in a limited quantity ○			
	<b>GIGP</b>	I	s	H	T	W	KM15	PM25	TIN25	TL20
	<b>GIGP10RN</b>	17,00	2,00	7,00	6,00	1,00			●	
	<b>GIGP10RR</b>	17,00	2,00	7,00	6,00	1,00			●	
	<b>GIGP10LN</b>	17,00	2,00	7,00	6,00	1,00			●	
	<b>GIGP10LL</b>	17,00	2,00	7,00	6,00	1,00			●	
	<b>GIGP15RN</b>	17,00	2,00	7,00	6,00	1,50			●	
	<b>GIGP15RR</b>	17,00	2,00	7,00	6,00	1,50			●	
	<b>GIGP15LN</b>	17,00	2,00	7,00	6,00	1,50			●	
	<b>GIGP15LL</b>	17,00	2,00	7,00	6,00	1,50			●	
	<b>GIGP20RN</b>	17,00	2,00	7,00	6,00	2,00			●	
	<b>GIGP20RR</b>	17,00	2,00	7,00	6,00	2,00			●	
	<b>GIGP20LN</b>	17,00	2,00	7,00	6,00	2,00			●	
	<b>GIGP20LL</b>	17,00	2,00	7,00	6,00	2,00			●	

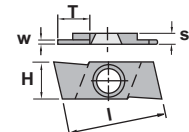
	Full radius grooving inserts						Normally available for immediate delivery ● Only available in a limited quantity ○			
	<b>GIGR</b>	I	s	H	T	W	KM15	PM25	TIN25	TL20
	<b>GIGR10R-L</b>	17,00	2,00	7,00	6,00	1,00			●	
	<b>GIGR15R-L</b>	17,00	2,00	7,00	6,00	1,50			●	
	<b>GIGR20R-L</b>	17,00	2,00	7,00	6,00	2,00			●	

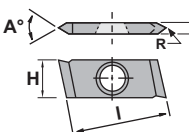
	Threading inserts						Normally available for immediate delivery ● Only available in a limited quantity ○			
	<b>GIGW</b>	I	s	H	R	A°	KM15	PM25	TIN25	TL20
	<b>GIGW55R-L</b>	17,00	2,00	7,00	0,10	55°			●	
	<b>GIGW60R-L</b>	17,00	2,00	7,00	0,10	60°			●	

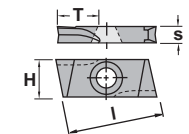
	Turning inserts						Normally available for immediate delivery ● Only available in a limited quantity ○			
	<b>GIST</b>	I	s	H	T	W	KM15	PM25	TIN25	TL20
	<b>GIST3R-L</b>	17,00	3,17	7,00	6,00	-			●	

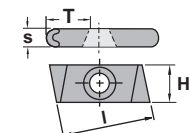
	Copying inserts						Normally available for immediate delivery ● Only available in a limited quantity ○			
	<b>GISC</b>	I	s	H	T	W	KM15	PM25	TIN25	TL20
	<b>GISC3R-L</b>	17,00	3,17	7,00	6,00	-			●	

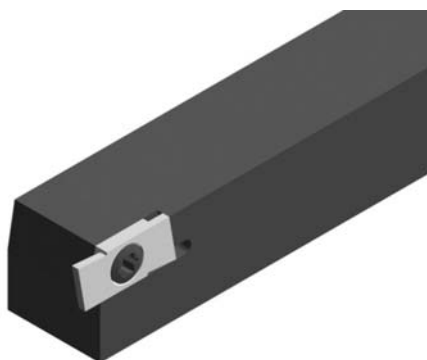

**Characteristics:**

Multipurpose toolholders for parting, grooving, threading and turning. The center screw clamping ensures good stability and rigidity. Ground shank for extra quality.

**Applications:**

Multipurpose toolholders for swiss.

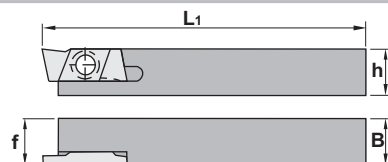

# STHE

Ref.		h	h1	B	L	f	Insert size	kg
STHER/L0808M07		8	8	8	150	8	GI..	0,070
STHER/L1010M07		10	10	10	150	10	GI..	0,110
STHER/L1212M07		12	12	12	150	12	GI..	0,150
STHER/L1616M07		16	16	16	150	16	GI..	0,280

Ref.			
STHER/L0808M07		1230	5508
STHER/L1010M07		1230	5508
STHER/L1212M07		1230	5508
STHER/L1616M07		1230	5508

Ref.	GI	l	s	H						
	GI..	17,00	2,00	7,00	GISG - Grooving inserts GIGP - Grooving and cutoff inserts GIGR - Full radius grooving inserts GIGW - Threading inserts GIST - Turning inserts GISC - Copying inserts					
	GISG	GIGP	GIGR	GIGW	GIST	GISC				

For more information see page: E.04

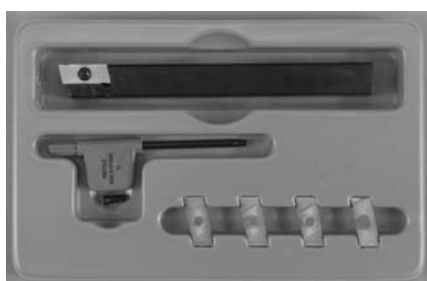

**Characteristics:**

Multipurpose toolholders set for parting, grooving, threading and turning. The center screw clamping ensures good stability and rigidity. Ground shank for extra quality.

**Applications:**

Multipurpose toolholders set.

# SET STHE

Ref.	Holder	Inserts											kg
		GISG09R	GISG11R	GISG13R	GISG16R	GISG185R	GIGP20RN	GIGW55R	GIGW60R	GIST3R	GISC3R		
SET STHER08	STHER0808M07	GISG09R	GISG11R	GISG13R	GISG16R	GISG185R	GIGP20RN	GIGW55R	GIGW60R	GIST3R	GISC3R	0,210	
SET STHEL08	STHEL0808M07	GISG09L	GISG11L	GISG13L	GISG16L	GISG185L	GIGP20LN	GIGW55L	GIGW60L	GIST3L	GISC3L	0,210	
SET STHER10	STHER1010M07	GISG09R	GISG11R	GISG13R	GISG16R	GISG185R	GIGP20RN	GIGW55R	GIGW60R	GIST3R	GISC3R	0,230	
SET STHEL10	STHEL1010M07	GISG09L	GISG11L	GISG13L	GISG16L	GISG185L	GIGP20LN	GIGW55L	GIGW60L	GIST3L	GISC3L	0,230	
SET STHER12	STHER1212M07	GISG09R	GISG11R	GISG13R	GISG16R	GISG185R	GIGP20RN	GIGW55R	GIGW60R	GIST3R	GISC3R	0,250	
SET STHEL12	STHEL1212M07	GISG09L	GISG11L	GISG13L	GISG16L	GISG185L	GIGP20LN	GIGW55L	GIGW60L	GIST3L	GISC3L	0,250	
SET STHER16	STHER1616M07	GISG09R	GISG11R	GISG13R	GISG16R	GISG185R	GIGP20RN	GIGW55R	GIGW60R	GIST3R	GISC3R	0,300	
SET STHEL16	STHEL1616M07	GISG09L	GISG11L	GISG13L	GISG16L	GISG185L	GIGP20LN	GIGW55L	GIGW60L	GIST3L	GISC3L	0,300	

Inserts

General turning

Aluminium wheel turning

Automatic lathes



**Characteristics:**  
Multipurpose boring bar for grooving, threading and turning.  
The easy screw clamping ensures good stability and rigidity.  
**Applications:**  
Multipurpose boring bar for smaller diameters from 4,2 mm.

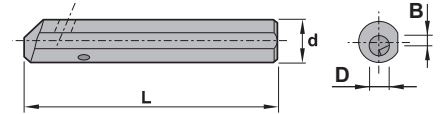

00.30		L	d	B	D	Tool size	Kg
Ref.	00.30.12.04	100	12	2,35	2,5 / 4,2	CTI 04..	0,070
	00.30.16.06	120	16	2,80	8,2	CTI 06..	0,150

Ref.	00.30.12.04		1505			5025	
	00.30.16.06		1506			5003	



AR		L	d	B	D <sub>min</sub>	r	 CTI 0402 AR CTI 0602 AR <b>Turning Tool</b>
Ref.	CTI 0402 AR	15	4	0,8	4,2	0,2	
	CTI 0602 AR	20	6	1,8	6,2	0,2	



BR		L	d	B	D <sub>min</sub>	r	 CTI 0402 BR CTI 0602 BR <b>Copying Tool</b>
Ref.	CTI 0402 BR	15	4	0,8	4,2	0,2	
	CTI 0602 BR	20	6	1,8	6,2	0,2	



CR		L	d	B	D <sub>min</sub>	r	 CTI 0400 CR CTI 0600 CR <b>Threading Tool</b>
Ref.	CTI 0400 CR	15	4	0,8	M5	-	
	CTI 0600 CR	20	6	1,8	M8	-	



DR		L	d	B	D <sub>min</sub>	r	 CTI 0410 DR CTI 0615 DR <b>Grooving Tool</b>
Ref.	CTI 0410 DR	15	4	1,0	4,2	-	
	CTI 0615 DR	20	6	1,8	6,2	-	



**Characteristics:**

Multipurpose boring bar set for grooving, threading and turning. The easy screw clamping ensures good stability and rigidity.

**Applications:**

Multipurpose boring bar set for smaller diameters from 4,2 mm..

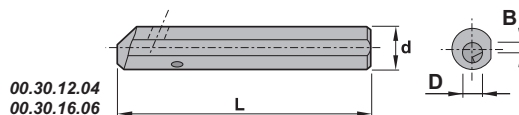

SET MT12		Characteristics: Boring bars with steel shank.					1505	5025	Kg
		L	d	B	D	r			
Ref.	00.30.12.04	100	12	2,35	2,5 / 4,2	-	1505	5025	0,170
	CTI 0402 AR	15	4	0,8	4,2	0,2			
	CTI 0402 BR	15	4	0,8	4,2	0,2			
	CTI 0400 CR	15	4	0,8	M5	-			
	CTI 0410 DR	15	4	1,0	4,2	-			

SET MT16		Characteristics: Boring bars with steel shank.					1506	5003	Kg
		L	d	B	D	r			
Ref.	00.30.16.06	120	16	2,8	8,2	-	1506	5003	0,250
	CTI 0602 AR	20	6	1,8	6,2	0,2			
	CTI 0602 BR	20	6	1,8	6,2	0,2			
	CTI 0600 CR	20	6	1,8	M8	-			
	CTI 0615 DR	20	6	1,8	6,2	-			

SET MT		Characteristics: Boring bars with steel shank.					1505	5025	Kg
		L	d	B	D	r			
Ref.	00.30.12.04	100	12	2,35	2,5 / 4,2	-	1505	5025	0,390
	00.30.16.06	120	16	2,80	8,2	-			
	CTI 0402 AR	15	4	0,8	4,2	0,2			
	CTI 0602 AR	20	6	1,8	6,2	0,2			
	CTI 0402 BR	15	4	0,8	4,2	0,2			
	CTI 0602 BR	20	6	1,8	6,2	0,2			
	CTI 0400 CR	15	4	0,8	M5	-			
	CTI 0600 CR	20	6	1,8	M8	-			
	CTI 0410 DR	15	4	1,0	4,2	-			
	CTI 0615 DR	20	6	1,8	6,2	-			

Automatic lathes

Ceramic tools

Parting and grooving

Threading

Drills

Cartridges

Brazed tools

Tooling

Inserts

General turning

Aluminium wheel turning

Automatic lathes



**Characteristics:**

Multipurpose boring bar for grooving, threading and turning. The easy screw clamping ensures good stability and rigidity.

**Applications:**

Multipurpose boring bar for smaller diameters from 8 mm..

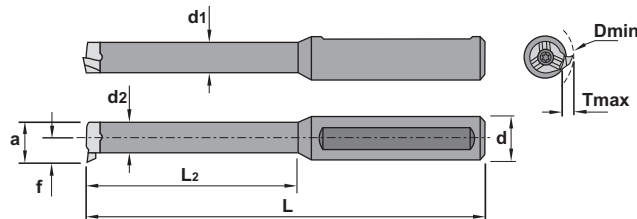

## 608.00

Ref.		Dmin	d	d1	d2	L	L2	a	f	Tmax	Insert size	kg
608.0012.2	HM	8	12	6	6	90	30	7,8	4,8	1,0	R/LS08	0,090
611.0012.2	HM	11	12	8	8	110	42	10,7	6,7	2,3	R/LS11	0,090
614.0012.2	HM	14	12	11	9,5	110	45	13,8	9,0	4,0	R/LS14	0,130
616.0012.2	HM	16	12	11	11	130	56	15,7	10,2	4,3	R/LS16	0,265



Ref.	608.0012.2	HM	1226	5508
	611.0012.2	HM	1535	5510
	614.0012.2	HM	1244	5515
	616.0012.2	HM	1255	5520



**Characteristics:**

Multipurpose mini-system boring bar for grooving, threading and turning. The easy screw clamping ensures good stability and rigidity.

**Applications:**

Multipurpose boring bar.

## SET 608

**Characteristics:**

Boring bars with steel shank.

Ref.	Holder	Holder	Inserts	Inserts	Inserts	Inserts	Inserts	kg
SET 6080012	608.0012.2	HM	RS008.0090	RS008.0110	RS008.0130	RS008.0160	RS08.0815.01	0,210
SET 6110012	611.0012.2	HM	RS011.0090	RS011.0110	RS011.0130	RS011.0160	RS11.0815.01	0,210
SET 6140012	614.0012.2	HM	RS014.0090	RS014.0110	RS014.0130	RS014.0160	RS14.0815.01	0,250
SET 6160012	616.0012.2	HM	RS016.0090	RS016.0110	RS016.0130	RS016.0160	RS16.0815.01	0,385

**L** Insert for turning Normally available for immediate delivery ●  
Only available in a limited quantity ○

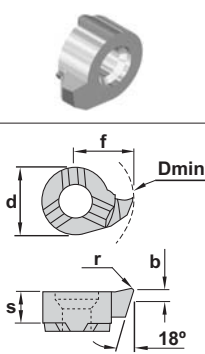

	Dmin	b	f	s	d	r	KM15	PM25	TIN25	TL20
LS08.1846.02	7,8	3,3	4,65	3,5	6,0	0,2				●
LS11.1855.02	9,8	3,9	5,50	4,2	8,0	0,2				●
LS11.1867.02	11,0	3,9	6,70	4,2	8,0	0,2				●
LS14.1867.02	13,8	5,0	8,70	5,1	9,0	0,2				●
LS16.1897.02	15,5	5,0	9,70	5,4	11,0	0,2				●

**R** Insert for turning Normally available for immediate delivery ●  
Only available in a limited quantity ○

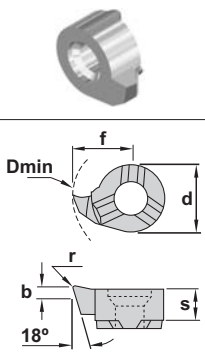

	Dmin	b	f	s	d	r	KM15	PM25	TIN25	TL20
RS08.1846.02	7,8	3,3	4,65	3,5	6,0	0,2				●
RS11.1855.02	9,8	3,9	5,50	4,2	8,0	0,2				●
RS11.1867.02	11,0	3,9	6,70	4,2	8,0	0,2				●
RS14.1867.02	13,8	5,0	8,70	5,1	9,0	0,2				●
RS16.1897.02	15,5	5,0	9,70	5,4	11,0	0,2				●

**L** Insert for grooving with radius Normally available for immediate delivery ●  
Only available in a limited quantity ○

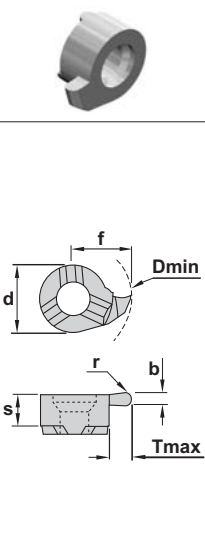

	Dmin	b	r	f	s	d	tmax	KM15	PM25	TIN25	TL20
LS08.008R04	8,0	0,8	0,4	4,8	3,3	6,0	1,0				●
LS08.012R06	8,0	1,2	0,6	4,8	3,3	6,0	1,0				●
LS08.018R09	8,0	1,8	0,9	4,8	3,3	6,0	1,0				●
LS11.008R04	11,0	0,8	0,4	6,7	4,2	8,0	2,3				●
LS11.012R06	11,0	1,2	0,6	6,7	4,2	8,0	2,3				●
LS11.018R09	11,0	1,8	0,9	6,7	4,2	8,0	2,3				●
LS11.020R10	11,0	2,0	1,0	6,7	4,2	8,0	2,3				●
LS11.030R15	11,0	3,0	1,5	6,7	4,2	8,0	2,3				●
LS14.012R06	14,0	1,2	0,6	9,0	4,0	9,0	4,0				●
LS14.018R09	14,0	1,8	0,9	9,0	4,0	9,0	4,0				●
LS14.020R10	14,0	2,0	1,0	9,0	4,0	9,0	4,0				●
LS14.022R11	14,0	2,2	1,1	9,0	4,0	9,0	4,0				●
LS14.030R15	14,0	3,0	1,5	9,0	4,0	9,0	4,0				●
LS16.018R09	16,0	1,8	0,9	10,2	5,4	11,0	4,3				●
LS16.022R11	16,0	2,2	1,1	10,2	5,4	11,0	4,3				●
LS16.030R15	16,0	3,0	1,5	10,2	5,4	11,0	4,3				●
LS16.040R20	16,0	4,0	2,0	10,2	5,4	11,0	4,3				●

**R** Insert for grooving with radius Normally available for immediate delivery ●  
Only available in a limited quantity ○

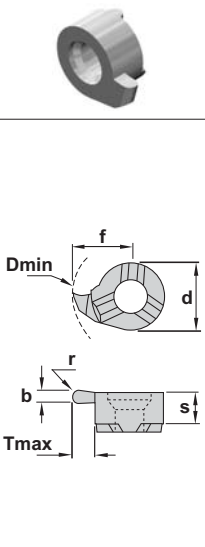

	Dmin	b	r	f	s	d	tmax	KM15	PM25	TIN25	TL20
RS08.008R04	8,0	0,8	0,4	4,8	3,3	6,0	1,0				●
RS08.012R06	8,0	1,2	0,6	4,8	3,3	6,0	1,0				●
RS08.018R09	8,0	1,8	0,9	4,8	3,3	6,0	1,0				●
RS11.008R04	11,0	0,8	0,4	6,7	4,2	8,0	2,3				●
RS11.012R06	11,0	1,2	0,6	6,7	4,2	8,0	2,3				●
RS11.018R09	11,0	1,8	0,9	6,7	4,2	8,0	2,3				●
RS11.020R10	11,0	2,0	1,0	6,7	4,2	8,0	2,3				●
RS11.030R15	11,0	3,0	1,5	6,7	4,2	8,0	2,3				●
RS14.012R06	14,0	1,2	0,6	9,0	4,0	9,0	4,0				●
RS14.018R09	14,0	1,8	0,9	9,0	4,0	9,0	4,0				●
RS14.020R10	14,0	2,0	1,0	9,0	4,0	9,0	4,0				●
RS14.022R11	14,0	2,2	1,1	9,0	4,0	9,0	4,0				●
RS14.030R15	14,0	3,0	1,5	9,0	4,0	9,0	4,0				●
RS16.018R09	16,0	1,8	0,9	10,2	5,4	11,0	4,3				●
RS16.022R11	16,0	2,2	1,1	10,2	5,4	11,0	4,3				●
RS16.030R15	16,0	3,0	1,5	10,2	5,4	11,0	4,3				●
RS16.040R20	16,0	4,0	2,0	10,2	5,4	11,0	4,3				●

Automatic lathes

Ceramic tools

Parting and grooving

Threading

Drills

Cartridges

Brazed tools

Tooling

Inserts

General turning

Aluminium wheel turning

Automatic lathes

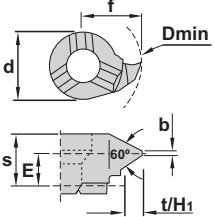
	Insert for threading										Normally available for immediate delivery ●				Only available in a limited quantity ○			
	L	Dmin	pitch.	t/H1	f	E	s	b	d	KM15	PM25	TIN25	TL20					
	LS08.0815.01	8,0	1,5 / 1,75	0,95	4,8	2,5	3,5	0,18	6,0				●					
	LS11.1020.01	11,0	2,0	1,08	6,7	3,0	4,3	0,25	8,0				●					
	LS11.1325.01	11,0	2,5	1,35	6,7	3,0	4,3	0,31	8,0				●					
	LS14.1020.01	14,0	2,0	1,08	9,0	4,2	5,4	0,25	9,0				●					
	LS14.1325.01	14,0	2,5	1,35	9,0	4,7	5,4	0,31	9,0				●					
	LS16.1325.01	16,0	2,5	1,35	10,2	4,2	5,5	0,31	11,0				●					
	LS08.0205.01	8,0	0,5 / 0,75	0,43	4,8	2,7	3,5	0,06	6,0				●					
	LS08.0510.01	8,0	1,0 / 1,25	0,70	4,8	2,7	3,5	0,12	6,0				●					
	LS11.0205.01	11,0	0,5 / 0,75	0,75	6,7	3,5	4,3	0,06	8,0				●					
	LS11.0510.01	11,0	1,0	0,55	6,7	3,5	4,3	0,12	8,0				●					
	LS11.0815.01	11,0	1,5	0,81	6,7	3,5	4,3	0,18	8,0				●					
	LS14.0510.01	14,0	1,0	0,55	9,0	4,7	5,4	0,12	9,0				●					
	LS14.0815.01	14,0	1,5	0,81	9,0	4,5	5,4	0,18	9,0				●					
	LS16.0510.01	16,0	1,0	0,55	10,2	4,7	5,5	0,12	11,0				●					
	LS16.0815.01	16,0	1,5	0,81	10,2	4,5	5,5	0,18	11,0				●					
	LS16.1020.01	16,0	2,0	1,08	10,2	4,2	5,5	0,25	11,0				●					

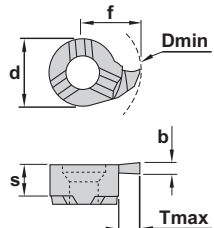
	Insert for grooving							Normally available for immediate delivery ●				Only available in a limited quantity ○			
	L	Dmin	b	f	s	d	T max.	KM15	PM25	TIN25	TL20				
	LS008.0070	8,0	0,73	4,8	3,3	6,0	1,0				●				
	LS008.0080	8,0	0,83	4,8	3,3	6,0	1,0				●				
	LS008.0090	8,0	0,93	4,8	3,3	6,0	1,0				●				
	LS008.0110	8,0	1,20	4,8	3,3	6,0	1,0				●				
	LS008.0130	8,0	1,40	4,8	3,3	6,0	1,0				●				
	LS008.0160	8,0	1,70	4,8	3,3	6,0	1,0				●				
	LS008.0100	8,0	1,00	4,8	3,3	6,0	1,0				●				
	LS008.0150	8,0	1,50	4,8	3,3	6,0	1,0				●				
	LS008.0200	8,0	2,00	4,8	3,3	6,0	1,0				●				
	LS011.0070	11,0	0,73	6,7	4,2	8,0	1,2				●				
	LS011.0080	11,0	0,83	6,7	4,2	8,0	1,3				●				
	LS011.0090	11,0	0,93	6,7	4,2	8,0	1,5				●				
	LS011.0110	11,0	1,20	6,7	4,2	8,0	2,3				●				
	LS011.0130	11,0	1,40	6,7	4,2	8,0	2,3				●				
	LS011.0160	11,0	1,70	6,7	4,2	8,0	2,3				●				
	LS011.0100	11,0	1,00	6,7	4,2	8,0	2,3				●				
	LS011.0150	11,0	1,50	6,7	4,2	8,0	2,3				●				
	LS011.0200	11,0	2,00	6,7	4,2	8,0	2,3				●				
	LS011.0250	11,0	2,50	6,7	4,2	8,0	2,3				●				
	LS011.0300	11,0	3,00	6,7	4,2	8,0	2,3				●				
	LS014.0070	14,0	0,73	9,0	5,3	9,0	1,2				●				
	LS014.0080	14,0	0,83	9,0	5,3	9,0	1,3				●				
	LS014.0090	14,0	0,93	9,0	5,3	9,0	1,5				●				
	LS014.0110	14,0	1,20	9,0	5,3	9,0	4,0				●				
	LS014.0130	14,0	1,40	9,0	5,3	9,0	4,0				●				
	LS014.0160	14,0	1,70	9,0	5,3	9,0	4,0				●				
	LS014.0150	14,0	1,50	9,0	5,3	9,0	4,0				●				
	LS014.0200	14,0	2,00	9,0	5,3	9,0	4,0				●				
	LS014.0250	14,0	2,50	9,0	5,3	9,0	4,0				●				
	LS014.0300	14,0	3,00	9,0	5,3	9,0	4,0				●				
	LS016.0070	16,0	0,73	10,2	5,4	11,0	1,2				●				
	LS016.0080	16,0	0,83	10,2	5,4	11,0	1,3				●				
	LS016.0090	16,0	0,93	10,2	5,4	11,0	1,5				●				
	LS016.0110	16,0	1,20	10,2	5,4	11,0	4,3				●				
	LS016.0130	16,0	1,40	10,2	5,4	11,0	4,3				●				
	LS016.0160	16,0	1,70	10,2	5,4	11,0	4,3				●				
LS016.0150	16,0	1,50	10,2	5,4	11,0	4,3				●					
LS016.0200	16,0	2,00	10,2	5,4	11,0	4,3				●					
LS016.0250	16,0	2,50	10,2	5,4	11,0	4,3				●					
LS016.0300	16,0	3,00	10,2	5,4	11,0	4,3				●					
LS016.0350	16,0	3,50	10,2	5,4	11,0	4,3				●					
LS016.0400	16,0	4,00	10,2	5,4	11,0	4,3				●					

**Insert for threading** Normally available for immediate delivery ●  
Only available in a limited quantity ○



**R**

	Dmin	pitch.	t/H1	f	E	s	b	d	KM15	PM25	TIN25	TL20
RS08.0815.01	8,0	1,5 / 1,75	0,95	4,8	2,5	3,5	0,18	6,0				●
RS11.1020.01	11,0	2,0	1,08	6,7	3,0	4,3	0,25	8,0				●
RS11.1325.01	11,0	2,5	1,35	6,7	3,0	4,3	0,31	8,0				●
RS14.1020.01	14,0	2,0	1,08	9,0	4,2	5,4	0,25	9,0				●
RS14.1325.01	14,0	2,5	1,35	9,0	4,7	5,4	0,31	9,0				●
RS16.1325.01	16,0	2,5	1,35	10,2	4,2	5,5	0,31	11,0				●
RS08.0205.01	8,0	0,5 / 0,75	0,43	4,8	2,7	3,5	0,06	6,0				●
RS08.0510.01	8,0	1,0 / 1,25	0,70	4,8	2,7	3,5	0,12	6,0				●
RS11.0205.01	11,0	0,5 / 0,75	0,75	6,7	3,5	4,3	0,06	8,0				●
RS11.0510.01	11,0	1,0	0,55	6,7	3,5	4,3	0,12	8,0				●
RS11.0815.01	11,0	1,5	0,81	6,7	3,5	4,3	0,18	8,0				●
RS14.0510.01	14,0	1,0	0,55	9,0	4,7	5,4	0,12	9,0				●
RS14.0815.01	14,0	1,5	0,81	9,0	4,5	5,4	0,18	9,0				●
RS16.0510.01	16,0	1,0	0,55	10,2	4,7	5,5	0,12	11,0				●
RS16.0815.01	16,0	1,5	0,81	10,2	4,5	5,5	0,18	11,0				●
RS16.1020.01	16,0	2,0	1,08	10,2	4,2	5,5	0,25	11,0				●

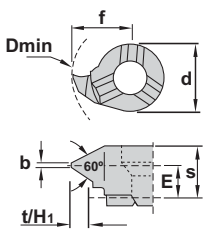

**Insert for grooving** Normally available for immediate delivery ●  
Only available in a limited quantity ○



**R**

	Dmin	b	f	s	d	T max.	KM15	PM25	TIN25	TL20
RS008.0070	8,0	0,73	4,8	3,3	6,0	1,0				●
RS008.0080	8,0	0,83	4,8	3,3	6,0	1,0				●
RS008.0090	8,0	0,93	4,8	3,3	6,0	1,0				●
RS008.0110	8,0	1,20	4,8	3,3	6,0	1,0				●
RS008.0130	8,0	1,40	4,8	3,3	6,0	1,0				●
RS008.0160	8,0	1,70	4,8	3,3	6,0	1,0				●
RS008.0100	8,0	1,00	4,8	3,3	6,0	1,0				●
RS008.0150	8,0	1,50	4,8	3,3	6,0	1,0				●
RS008.0200	8,0	2,00	4,8	3,3	6,0	1,0				●
RS011.0070	11,0	0,73	6,7	4,2	8,0	1,2				●
RS011.0080	11,0	0,83	6,7	4,2	8,0	1,3				●
RS011.0090	11,0	0,93	6,7	4,2	8,0	1,5				●
RS011.0110	11,0	1,20	6,7	4,2	8,0	2,3				●
RS011.0130	11,0	1,40	6,7	4,2	8,0	2,3				●
RS011.0160	11,0	1,70	6,7	4,2	8,0	2,3				●
RS011.0100	11,0	1,00	6,7	4,2	8,0	2,3				●
RS011.0150	11,0	1,50	6,7	4,2	8,0	2,3				●
RS011.0200	11,0	2,00	6,7	4,2	8,0	2,3				●
RS011.0250	11,0	2,50	6,7	4,2	8,0	2,3				●
RS011.0300	11,0	3,00	6,7	4,2	8,0	2,3				●
RS014.0070	14,0	0,73	9,0	5,3	9,0	1,2				●
RS014.0080	14,0	0,83	9,0	5,3	9,0	1,3				●
RS014.0090	14,0	0,93	9,0	5,3	9,0	1,5				●
RS014.0110	14,0	1,20	9,0	5,3	9,0	4,0				●
RS014.0130	14,0	1,40	9,0	5,3	9,0	4,0				●
RS014.0160	14,0	1,70	9,0	5,3	9,0	4,0				●
RS014.0150	14,0	1,50	9,0	5,3	9,0	4,0				●
RS014.0200	14,0	2,00	9,0	5,3	9,0	4,0				●
RS014.0250	14,0	2,50	9,0	5,3	9,0	4,0				●
RS014.0300	14,0	3,00	9,0	5,3	9,0	4,0				●
RS016.0070	16,0	0,73	10,2	5,4	11,0	1,2				●
RS016.0080	16,0	0,83	10,2	5,4	11,0	1,3				●
RS016.0090	16,0	0,93	10,2	5,4	11,0	1,5				●
RS016.0110	16,0	1,20	10,2	5,4	11,0	4,3				●
RS016.0130	16,0	1,40	10,2	5,4	11,0	4,3				●
RS016.0160	16,0	1,70	10,2	5,4	11,0	4,3				●
RS016.0150	16,0	1,50	10,2	5,4	11,0	4,3				●
RS016.0200	16,0	2,00	10,2	5,4	11,0	4,3				●
RS016.0250	16,0	2,50	10,2	5,4	11,0	4,3				●
RS016.0300	16,0	3,00	10,2	5,4	11,0	4,3				●
RS016.0350	16,0	3,50	10,2	5,4	11,0	4,3				●
RS016.0400	16,0	4,00	10,2	5,4	11,0	4,3				●

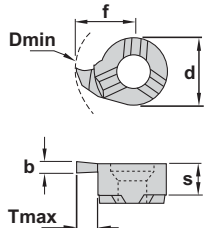

Automatic lathes

Ceramic tools

Parting and grooving

Threading

Drills

Cartridges

Brazed tools

Tooling

Inserts

General turning

Aluminium wheel turning

Automatic lathes

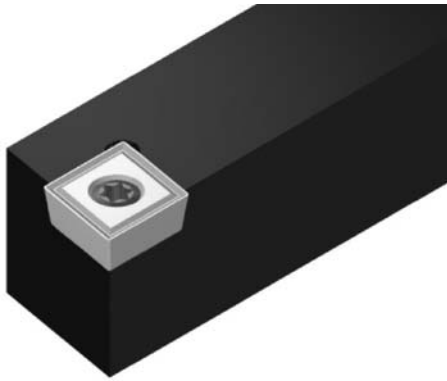

**Characteristics:**

Toolholder for external turning applications equipped with rhombic positive inserts (angle 80°). The center screw ensures good rigidity and chip flow.

**Applications:**

External turning toolholder for all kind of materials. The workpiece should be stable.

**Axial:** 0°  
**Radial:** 0°

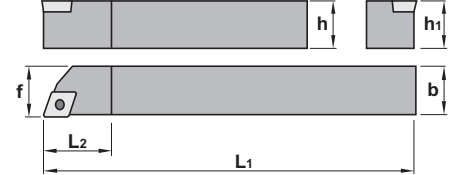
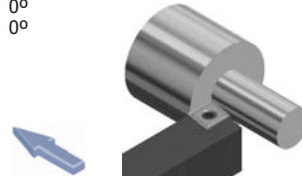

**SCAC 90°**

Ref.		h=h <sub>1</sub>	b	L <sub>1</sub>	L <sub>2</sub>	f	Insert size	Kg
SCAC R/L 0808 M06	SCAC R/L 0808 M06	8	8	150	8	8	CC.. 0602..	0,070
	SCAC R/L 1010 M06	10	10	150	10	10	CC.. 0602..	0,110
	SCAC R/L 1212 M06	12	12	150	12	12	CC.. 0602..	0,150
	SCAC R/L 1616 M06	16	16	150	16	16	CC.. 0602..	0,280
SCAC R/L 1212 M09	SCAC R/L 1212 M09	12	12	150	12	12	CC.. 09T3..	0,150
	SCAC R/L 1616 M09	16	16	150	16	16	CC.. 09T3..	0,280

Ref.			
SCAC R/L 0808 M06	SCAC R/L 0808 M06	1225	5507
	SCAC R/L 1010 M06	1225	5507
	SCAC R/L 1212 M06	1225	5507
	SCAC R/L 1616 M06	1225	5507
SCAC R/L 1212 M09	SCAC R/L 1212 M09	1240	5515
	SCAC R/L 1616 M09	1240	5515

Ref.	CC..	l	s	d	Positive 7° clearance - 80° rhombic inserts.
	CC.. 0602..	6,45	2,38	6,35	
CC.. 09T3..	9,65	3,97	9,52		

CCGT-AL	CCGT-AP	CCMT-03	CCMW

For more information see page: A.18

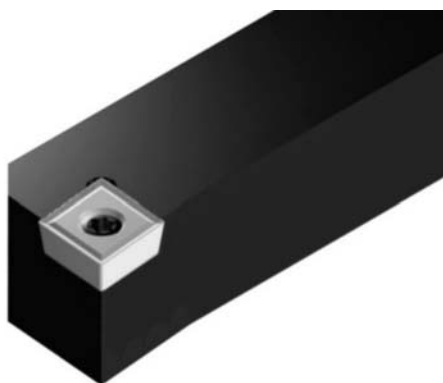

**Characteristics:**

Multipurpose toolholder equipped with rhombic positive insert (angle 80°).  
The center screw ensures good rigidity and chip flow.

**Applications:**

External turning toolholder for general applications. roughing, semi-finishing and finishing.

Axial: 0°  
Radial: 0°

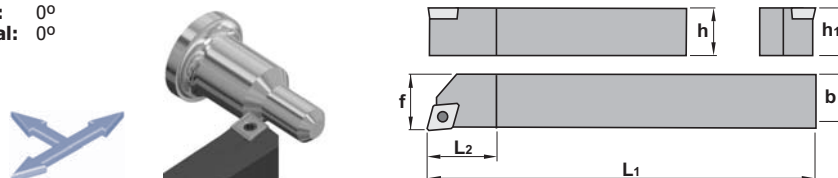

## SCLC 95°

Ref.		h=h1	b	L1	L2	f	Insert size	Kg
SCLC R/L M06	SCLC R/L 0808 M06	8	8	150	8	8	CC.. 0602..	0,070
	SCLC R/L 1010 M06	10	10	150	10	10	CC.. 0602..	0,110
	SCLC R/L 1212 M06	12	12	150	12	12	CC.. 0602..	0,150
	SCLC R/L 1616 M06	16	16	150	16	16	CC.. 0602..	0,280
SCLC R/L M09	SCLC R/L 1212 M09	12	12	150	12	12	CC.. 09T3..	0,150
	SCLC R/L 1616 M09	16	16	150	16	16	CC.. 09T3..	0,280

Ref.			
SCLC R/L M06	SCLC R/L 0808 M06	1225	5507
	SCLC R/L 1010 M06	1225	5507
	SCLC R/L 1212 M06	1225	5507
	SCLC R/L 1616 M06	1225	5507
SCLC R/L M09	SCLC R/L 1212 M09	1240	5515
	SCLC R/L 1616 M09	1240	5515

Ref.	CC..	l	s	d	Positive 7° clearance - 80° rhombic inserts.
	CC.. 0602..	6,45	2,38	6,35	
CC.. 09T3..	9,65	3,97	9,52		

CCGT-AL	CCGT-AP	CCMT-03	CCMW

For more information see page: A.18

Automatic lathes

Ceramic tools

Parting and grooving

Threading

Drills

Cartridges

Brazed tools

Tooling

Inserts  
General turning  
Aluminium wheel turning  
Automatic lathes



**Characteristics:**

Multipurpose toolholder equipped with rhombic positive insert (angle 55°). The center screw ensures good rigidity and chip flow.

**Applications:**

External turning toolholder for general applications, roughing, semi-finishing and finishing.

**Axial:** 0°  
**Radial:** 0°

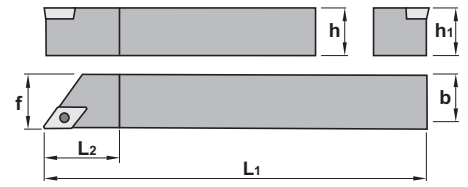

SDAC 90°		h=h1	b	L1	L2	f	Insert size	Kg
Ref.	SDAC R/L 0808 M07	8	8	150	12,7	8	DC.. 0702..	0,070
	SDAC R/L 1010 M07	10	10	150	15,0	10	DC.. 0702..	0,110
	SDAC R/L 1212 M07	12	12	150	15,0	12	DC.. 0702..	0,150
	SDAC R/L 1616 M07	16	16	150	16,0	16	DC.. 0702..	0,280
	SDAC R/L 1212 M11	12	12	150	18,0	12	DC.. 11T3..	0,150
	SDAC R/L 1616 M11	16	16	150	20,0	16	DC.. 11T3..	0,280

Ref.	SDAC R/L 0808 M07	SDAC R/L 1010 M07	SDAC R/L 1212 M07	SDAC R/L 1616 M07	SDAC R/L 1212 M11	SDAC R/L 1616 M11
	1225	1225	1225	1225	1240	1240
	5507	5507	5507	5507	5515	5515

	DC..				Positive 7° clearance - 55° rhombic inserts.
	Ref.	l	s	d	
	DC.. 0702..	7,75	2,38	6,35	
DC.. 11T3..	11,60	3,97	9,52		
For more information see page: A.21					
	DCGT-AL	DCGT-AP	DCMT-03	DCMW	



**Characteristics:**

Multipurpose toolholder equipped with rhombic positive insert (angle 55°).  
The center screw ensures good rigidity and chip flow.

**Applications:**

Profiling toolholder for general applications. roughing, semi-finishing and finishing.

**Axial:** 0°  
**Radial:** 0°

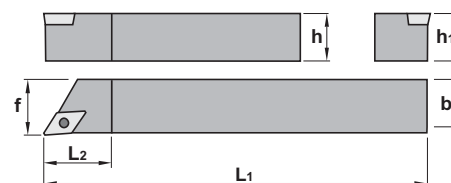

## SDJC 93°

Ref.		h=h <sub>1</sub>	b	L <sub>1</sub>	L <sub>2</sub>	f	Insert size	Kg
SDJC R/L 0808 M07	SDJC R/L 0808 M07	8	8	150	8	8	DC.. 0702..	0,070
	SDJC R/L 1010 M07	10	10	150	10	10	DC.. 0702..	0,110
	SDJC R/L 1212 M07	12	12	150	12	12	DC.. 0702..	0,150
	SDJC R/L 1616 M07	16	16	150	16	16	DC.. 0702..	0,280
SDJC R/L 1212 M11	SDJC R/L 1212 M11	12	12	150	12	12	DC.. 11T3..	0,150
	SDJC R/L 1616 M11	16	16	150	16	16	DC.. 11T3..	0,280

Automatic lathes

Ceramic tools

Parting and grooving

Threading

Drills

Cartridges

Brazed tools

Tooling

Ref.			
SDJC R/L 0808 M07	SDJC R/L 0808 M07	1225	5507
	SDJC R/L 1010 M07	1225	5507
	SDJC R/L 1212 M07	1225	5507
	SDJC R/L 1616 M07	1225	5507
SDJC R/L 1212 M11	SDJC R/L 1212 M11	1240	5515
	SDJC R/L 1616 M11	1240	5515

Ref.	DC..	l	s	d	Positive 7° clearance - 55° rhombic inserts.
	DC.. 0702..	7,75	2,38	6,35	
DC.. 11T3..	11,60	3,97	9,52		

DCGT-AL	DCGT-AP	DCMT-03	DCMW

For more information see page: A.21

Inserts

General turning

Aluminium wheel turning

Automatic lathes



**Characteristics:**

Multipurpose toolholder equipped with rhombic positive insert (angle 55°). The center screw ensures good rigidity and chip flow.

**Applications:**

External turning toolholder for general applications. roughing, semi-finishing and finishing.

**Axial:** 0°  
**Radial:** 0°

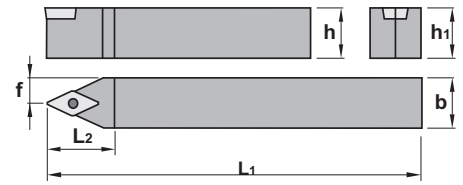
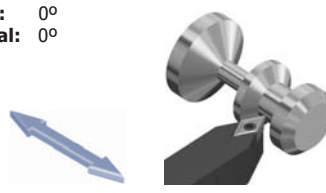

**SDNC 63°**

Ref.		h=h1	b	L1	L2	f	Insert size	Kg
SDNC N 1010 M07		10	10	150	15	5,2	DC.. 0702..	0,100
SDNC N 1212 M11		12	12	150	21	6,2	DC.. 11T3..	0,140
SDNC N 1616 M11		16	16	150	21	8,6	DC.. 11T3..	0,270

Ref.			
SDNC N 1010 M07		1225	5507
SDNC N 1212 M11		1240	5515
SDNC N 1616 M11		1240	5515

Ref.	DC..				Positive 7° clearance - 55° rhombic inserts.
	l	s	d		
DC.. 0702..	7,75	2,38	6,35		For more information see page: A.21
DC.. 11T3..	11,60	3,97	9,52		
	<b>DCGT-AL</b>	<b>DCGT-AP</b>	<b>DCMT-03</b>	<b>DCMW</b>	

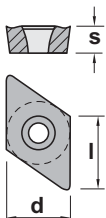



**Characteristics:**

Toolholder for external and face turning applications equipped with triangular positive inserts. The center screw ensures good rigidity and chip flow.

**Applications:**

External and face turning and toolholder for all kind of materials. The workpiece should be stable.

Axial rake: 0°  
Radial rake: 0°

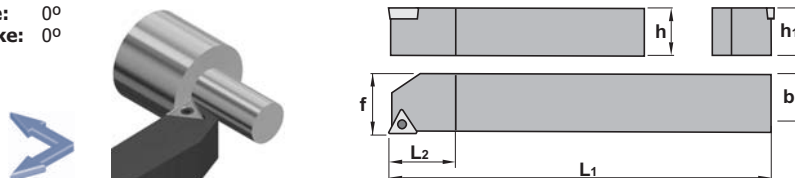

## STJC 93°

Ref.		h=h <sub>1</sub>	b	L <sub>1</sub>	L <sub>2</sub>	f	Insert size	Kg
STJC R/L 1010 M11		10	10	150	16	10	TC.. 1102..	0,110
STJC R/L 1212 M11		12	12	150	16	12	TC.. 1102..	0,150
STJC R/L 1616 M11		16	16	150	16	16	TC.. 1102..	0,280

Ref.			
STJC R/L 1010 M11		1225	5507
STJC R/L 1212 M11		1225	5507
STJC R/L 1616 M11		1225	5507

	TC..			Positive 7° clearance - Triangular inserts.
	l	s	d	
Ref. TC.. 1102..	11,00	2,38	6,35	
	TCGT-AL	TCMT-03	TCMW	

For more information see page: A.28

Automatic lathes

Ceramic tools

Parting and grooving

Threading

Drills

Cartridges

Brazed tools

Tooling

Inserts  
General turning  
Aluminium wheel turning  
Automatic lathes



**Characteristics:**

Multipurpose toolholder equipped with rhombic positive insert (angle 35°). The center screw ensures good rigidity and chip flow.

**Applications:**

Profiling toolholder for general applications, roughing, semi-finishing and finishing.

**Axial:** 0°  
**Radial:** 0°

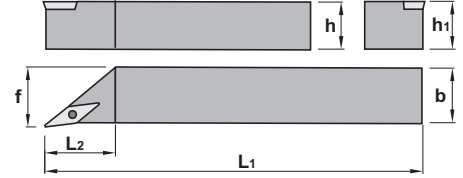
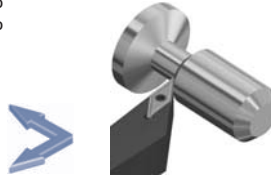

SVAC 90°		h=h <sub>1</sub>	b	L <sub>1</sub>	L <sub>2</sub>	f	Insert size	Kg
Ref.	SVAC R/L 0808 M11	8	8	150	26	8	VC.. 1103..	0,070
	SVAC R/L 1010 M11	10	10	150	26	10	VC.. 1103..	0,100
	SVAC R/L 1212 M11	12	12	150	26	12	VC.. 1103..	0,140
	SVAC R/L 1616 M11	16	16	150	26	16	VC.. 1103..	0,270
	SVAC R/L 1212 M16	12	12	150	40	12	VC.. 1604..	0,140
	SVAC R/L 1616 M16	16	16	150	40	16	VC.. 1604..	0,270

Ref.		
SVAC R/L 0808 M11	1225	5507
SVAC R/L 1010 M11	1225	5507
SVAC R/L 1212 M11	1225	5507
SVAC R/L 1616 M11	1225	5507
SVAC R/L 1212 M16	1240	5515
SVAC R/L 1616 M16	1240	5515

	VC..			Positive 7° clearance - 35° rhombic inserts
	Ref.	l	s	
	VC.. 1103..	11,00	3,18	6,35
	VC.. 1604..	16,50	4,76	9,52
	VCGT-AL	VCGT-AP	VCMT-03	

For more information see page: A.32



**Characteristics:**

Multipurpose toolholder equipped with rhombic positive insert (angle 35°).  
The center screw ensures good rigidity and chip flow.

**Applications:**

Profiling toolholder for general applications, roughing, semi-finishing and finishing.

**Axial:** 0°  
**Radial:** 0°

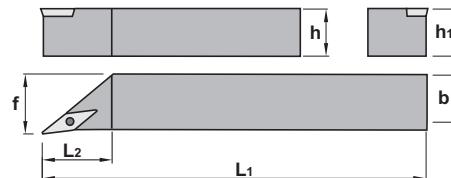
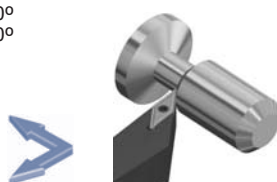

## SVJC 93°

Ref.		h=h <sub>1</sub>	b	L <sub>1</sub>	L <sub>2</sub>	f	Insert size	Kg
SVJC R/L 0808 M11	SVJC R/L 0808 M11	8	8	150	26	8	VC.. 1103..	0,070
	SVJC R/L 1010 M11	10	10	150	26	10	VC.. 1103..	0,100
	SVJC R/L 1212 M11	12	12	150	26	12	VC.. 1103..	0,140
	SVJC R/L 1616 M11	16	16	150	26	16	VC.. 1103..	0,270
SVJC R/L 1212 M16	SVJC R/L 1212 M16	12	12	150	40	12	VC.. 1604..	0,140
	SVJC R/L 1616 M16	16	16	150	40	16	VC.. 1604..	0,270

Automatic lathes

Ceramic tools

Parting and grooving

Threading

Drills

Cartridges

Brazed tools

Tooling

Ref.			
SVJC R/L 0808 M11	SVJC R/L 0808 M11	1225	5507
	SVJC R/L 1010 M11	1225	5507
	SVJC R/L 1212 M11	1225	5507
	SVJC R/L 1616 M11	1225	5507
SVJC R/L 1212 M16	SVJC R/L 1212 M16	1240	5515
	SVJC R/L 1616 M16	1240	5515

Ref.	VC..			Positive 7° clearance - 35° rhombic inserts
	l	s	d	
VC.. 1103..	11,00	3,18	6,35	For more information see page: A.32
VC.. 1604..	16,50	4,76	9,52	
VCMT-03				
VCMT-03				

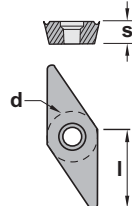

Inserts  
 General turning  
 Aluminium wheel turning  
 Automatic lathes

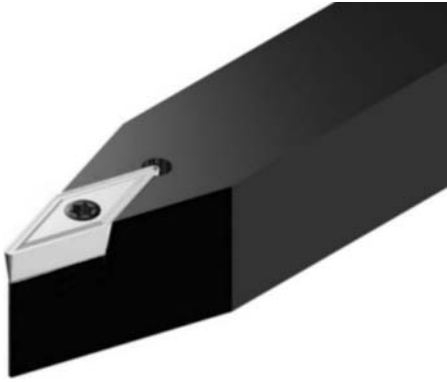

**Characteristics:**

Multipurpose toolholder equipped with rhombic 5° positive insert (angle 35°).  
The center screw ensures good rigidity and chip flow.

**Applications:**

Profiling toolholder for general applications, roughing, semi-finishing and finishing.

**Axial:** 0°  
**Radial:** 0°

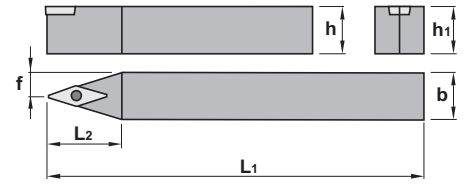
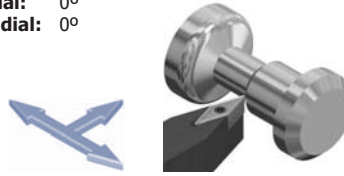

**SVVC 72°30'**

Ref.		h=h1	b	L1	L2	f	Insert size	Kg
SVVC N 0808 M11		8	8	150	21	4,3	VC.. 1103..	0,070
SVVC N 1010 M11		10	10	150	21	5,3	VC.. 1103..	0,100
SVVC N 1212 M11		12	12	150	21	6,3	VC.. 1103..	0,140
SVVC N 1616 M11		16	16	150	21	8,3	VC.. 1103..	0,260

Ref.			
SVVC N 0808 M11		1225	5507
SVVC N 1010 M11		1225	5507
SVVC N 1212 M11		1225	5507
SVVC N 1616 M11		1225	5507

	VC..			Positive 7° clearance - 35° rhombic inserts
	Ref.	l	s	
	VC.. 1103..	11,00	3,18	6,35
	VCGT-AL	VCGT-AP	VCMT-03	

For more information see page: A.32

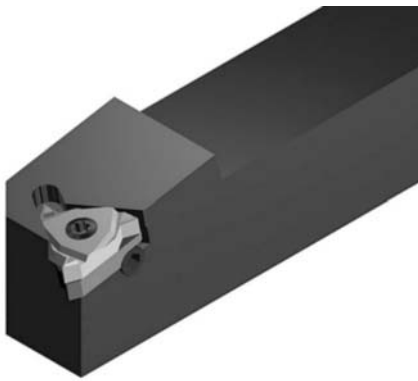

**Characteristics:**

Threading toolholder for negative lay down inserts.  
 The screw clamping ensures a good and clean fixation.  
 The insert is positioned with a  $-10^\circ$  cutting angle, and a  $-1^\circ$  clearance angle.  
 Toolholder supplied with all the spare parts except the insert.

**Applications:**

Threading toolholders.

**Axial:**  $-10^\circ$   
**Radial:**  $-1^\circ$

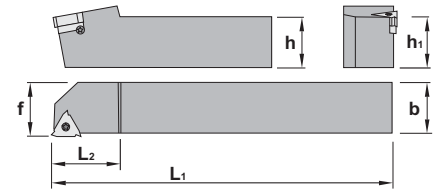
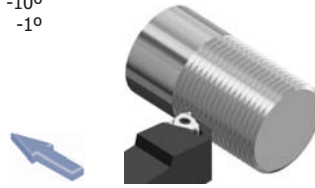

## SXAN 90°

Ref.		h=h <sub>1</sub>	b	L <sub>1</sub>	L <sub>2</sub>	f	Insert size	kg
SXAN R/L 0808 M08		8	8	150	20	8	08 ER/L..	0,070
	SXAN R/L 1010 M08	10	10	150	20	10	08 ER/L..	0,100
SXAN R/L 1212 M11		12	12	150	20	12	11 ER/L..	0,140
SXAN R/L 1616 M16		16	16	150	22	16	16 ER/L..	0,270

Ref.					
SXAN R/L 0808 M08	1225	5507	-	-	-
SXAN R/L 1010 M08	1225	5507	-	-	-
SXAN R/L 1212 M11	1225	5507	-	-	-
SXAN R/L 1616 M16	1335	5515	3424	3425	1093

Ref.	E R/L	l	d	Negative triangular inserts for external threading			
	08 ER/L..		8,00	4,76	For more information see page: H.06		
11 ER/L..		11,00	6,35				
16 ER/L..		16,50	9,52				
	ER/L	ER/L TD					

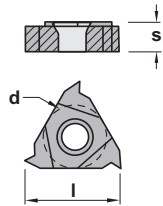

Inserts

General turning

Aluminium wheel turning

Automatic lathes



**Characteristics:**

One sided inserts with thickness from 1,6 to 6 mm.

The "V" positioning system of the pocket and the clamp integrated to the tool ensure maximum security and repetitivity on the dimensions when the insert is changed.

**Applications:**

Parting and grooving toolholder taht works well on steels, alloyed steels, stainless steels and refractories.

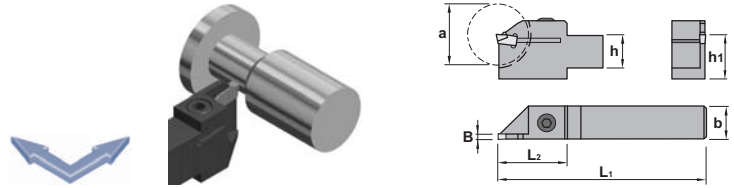

**CZCB**

Ref.		h	b	L1	L2	h1	B	a	Insert size	$\Delta$ Kg
CZCB R/L 1010 J01		10	10	110	25	21	1,6	22	MRCN 1,6	0,080
	CZCB R/L 1010 J02	10	10	110	25	21	2,2	22	MRCN 2,2	0,080
CZCB R/L 1212 J01		12	12	110	25	21	1,6	22	MRCN 1,6	0,100
	CZCB R/L 1212 J02	12	12	110	25	21	2,2	22	MRCN 2,2	0,100
CZCB R/L 1612 J02		16	12	110	29	21	2,2	32	MRCN 2,2	0,150
	CZCB R/L 1612 J03	16	12	110	29	21	3,0	32	MRCN 3,0	0,150
CZCB R/L 2016 K03		20	16	125	35	30	3,0	42	MRCN 3,0	0,350
	CZCB R/L 2016 K04	20	16	125	35	30	4,0	42	MRCN 4,0	0,350
CZCB R/L 2016 K05		20	16	125	35	30	5,0	42	MRCN 5,0	0,350
	CZCB R/L 2016 K06	20	16	125	35	30	6,0	42	MRCN 6,0	0,350
CZCB R/L 2520 M03		25	20	150	50	30	3,0	80	MRCN 3,0	0,550
	CZCB R/L 2520 M04	25	20	150	50	30	4,0	80	MRCN 4,0	0,550
CZCB R/L 2520 M05		25	20	150	50	30	5,0	80	MRCN 5,0	0,550
	CZCB R/L 2520 M06	25	20	150	50	30	6,0	80	MRCN 6,0	0,550

Ref.			
CZCB R/L 1010 J01		1905	5004
	CZCB R/L 1010 J02	1905	5004
CZCB R/L 1212 J01		1905	5004
	CZCB R/L 1212 J02	1905	5004
CZCB R/L 1612 J02		1916	5005
	CZCB R/L 1612 J03	1916	5005
CZCB R/L 2016 K03		1906	5005
	CZCB R/L 2016 K04	1906	5005
CZCB R/L 2016 K05		1906	5005
	CZCB R/L 2016 K06	1906	5005
CZCB R/L 2520 M03		1906	5005
	CZCB R/L 2520 M04	1906	5005
CZCB R/L 2520 M05		1906	5005
	CZCB R/L 2520 M06	1906	5005

Ref.	MRCN		s		r		Single-ended insert for parting and grooving
	MRCN 1,6		1,6		0,15		
MRCN 2,2		2,2		0,20			
MRCN 3,0		3,0		0,20			
MRCN 4,0		4,0		0,20			
MRCN 5,0		5,0		0,30			
MRCN 6,0		6,0		0,40			
For more information see page: G.03							

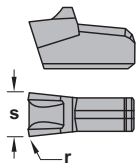

## Nominal cutting speed and feed values for automatic lathes

Material	P	HB	Condition	Cutting speed m/min.						Specific cutting force K <sub>0,4</sub>
				PM 25	PM 40	NC 25	TIN 16	TIN 22	TIN 32	
				0.3-0.6-1.2		0.1 - 0.3	0.1-0.4-0.8	0.1-0.4-0.8	0.2-0.5-1.2	
Unalloyed steel	125	C=0.15%		150 115 80		350 280	480 345 250	440 300 205	330 230 110	1900
	150	C=0.35%		145 105 70		270 230	440 315 230	400 275 190	300 210 150	2100
	200	C=0.60%		115 90 65		240 190	385 275 200	350 240 165	260 185 130	2250
Low alloyed steel	180	Annealed		90 70 45		300 260	380 265 195	320 220 170	200 140 100	2100
	275	Hardened		65 45 30		220 140	260 180 130	215 150 115	140 100 70	2600
	300	Hardened		60 40 25		230 180	240 165 120	200 135 105	125 90 60	2700
	350	Hardened		50 35 20		220 140	210 145 105	170 120 90	110 75 55	2850
High alloyed steel	200	Annealed		80 60 45		200 160	350 230 170	280 185 135	175 115 80	2600
	325	Hardened		40 25 20		200 160	170 110	120 80 60	85 55 40	3900
Stainless steel	200	Martensitic/Ferritic		110 95 75		270 130	295 240 190	275 210 165	225 180 145	2300
Steel castings	180	Unalloyed		60 50 35		300 260	260 185 145	230 160 120	135 105 75	2000
	200	Low alloyed		50 45 30		230 180	230 160 120	190 125 85	120 90 60	2500
	225	High alloyed		40 30 20		220 140	190 130 95	170 115 80	95 70 55	2700

Material	M	HB	Condition	Cutting speed m/min.						Specific cutting force K <sub>0,4</sub>		
				PM 25	PM 40	NC 25	TIN 16	TIN 17	TIN 22		TIN 32	TIN 35
				0.1-0.3		0.1-0.3	0.1-0.4-0.8	0.1-0.3			0.2-0.4-0.6	0.2-0.4-0.6
Stainless steel annealed	180	Austenitic Ni > 8%, Cr 12-25% Austenitic/Ferritic Austenitic/Ferritic, Low S		205 170	240 200	180 150 120	600 100		190 160 130	190 160 130	2450	
					160 130	180 150 120	400 100		190 160 100	190 160 130		
					160 130	180 150 120	400 100		140 110	160 130 100		
Heat resistant alloys	200	Annealed				50 20		40 20	40 20	3000		
	280	Aged				50 20		35 15	35 15	3050		
	250	Annealed				40 15		25 6	25 8	3500		
	350	Aged				35 20		15 4	15 4	4150		
320	Cast				25 10		15 4	15 4	4150			
Titanium alloys	400	Ti				140 80			80 130	1530		
	950	Cast a, almost a and a+b				45 25			15 35	1675		
	1050	Aged cast a+b				45 25			15 35	1690		

Material	K	HB	Condition	Cutting speed m/min.						Specific cutting force K <sub>0,4</sub>
				KM 15	TIN 17	NC 25	TIN 16	TIN 22	ZR 10	
				0.2-0.5-1.0	0.2-0.5-1.0	0.2-0.5	0.2-0.5-1.0		0.2-0.5-1.0	
Hardened steel	350	Hardened steel		27 16 10	180 150 110		175 145 100			4500
	250	Manganese steel 12%		65 40 16	120 90 60		120 85 50			3600
Malleable cast iron	130	Ferritic		105 75 45	250 180 100		225 150 90			1100
	230	Pearlitic		80 60 30	160 100 60		155 95 55			1100
Cast iron	180	Low tensile strength		135 95 60	180 120 80	300 200	165 110 70			1100
	260	High tensile strength		95 65 40	140 105 60	250 180	120 90 55			1500
Nodular SG iron	160	Ferritic		115 80 45	220 180 100	250 180				1100
	250	Pearlitic		80 50 30	150 100 50	180 120				1800
Chilled cast iron	400			17 11	17 11					3000
Aluminium alloys	60	Non heat treatable		1750 1280 800	1750 1280 800				1750 1280 800	500
	100	Heat treatable		510 370 250	510 370 250				510 370 250	800
Aluminium alloys (Cast)	75	Non heat treatable		460 285 175	460 285 175				460 285 175	750
	90	Heat treatable		300 180 110	300 180 110				300 180 110	900
Bronze - Brass alloys	110	Lead alloys, Pb>1%		610 430 295	610 430 295				610 430 295	700
	90	Brass and bronze		310 250 195	310 250 195				310 250 195	750
	100	Inc. electrolytic copper		225 160 115	225 160 115				225 160 115	1750
Other materials		Hard plastics		380 240	380 240				380 240	
		Fibre		190 120	190 120				190 120	
		Hard rubber		225 160	225 160				225 160	